



Genuine Parts

Your business is worth it.





Order Online Now!
www.ahbinc.com

If you do not already have a kmtgenuineparts.com log-in, you will need to first call KMT Customer Service at 800-991-4225, and they will be happy to set you up with your personalized log-in information.

- Toll Free Order-line: **800-991-4225**
- E-mail: **customerservice@ahbinc.com**

Please make a note of your pump model number(s) and serial number(s) for future reference when ordering:

Model #:

Serial #:



Over 40 years ago the very first commercial installation of a waterjet cutting system began operation using a KMT intensifier. Since then, KMT intensifiers with KMT Genuine Parts have served customers reliably across many industries, including yours.

KMT Genuine Parts are manufactured in the USA to the exact standards as the original parts found on new KMT pumps. Our expertise and operating experience extends from the original SL-I operating at 55,000 psi all the way to today's industry-leading KMT PRO intensifier cutting at 90,000 psi. No other provider has this breadth of experience and you can rest assured that your KMT intensifier will operate at peak performance when you use KMT Genuine Parts.

Benefits of KMT Genuine Parts:

- **Robust quality control inspection process to ensure superior fit and durability**
- **Manufactured to precise specifications best suited for your KMT intensifier**
- **Improvements made to KMT intensifiers are incorporated into KMT Genuine Parts**
- **KMT Customer Service and Technical Support is available 24/7 and most parts ship same-day when ordered before 4PM Central.**

Remember to use KMT Genuine Parts to maintain your intensifier warranty and ensure that your investment pays off over the long-term. The use of imitation parts will void warranty coverage, compromise safety and may result in reduced component lifetime.

Decades of precision manufacturing and engineering experience, proprietary manufacturing processes and patented technology make KMT Genuine Parts an exceptional value – your business is worth it.

A handwritten signature in black ink, appearing to read 'Steve M. Davis', is written over a white background.

Steve Davis
Director Aftermarket Business

KMT Waterjet Preventive Maintenance

Experienced Support for Maximum Performance and Reliability.

KMT Service Technicians provide the waterjet industry's best technical support averaging over 15 years of waterjet experience. KMT offers a Preventive Maintenance (PM) Program which provides a 65 Point Comprehensive Inspection for your KMT pumps, parts and components.

Benefits of the KMT PM Program

- Improves operational performance, efficiency and dependability.
- Enable end users to focus resources on core business.
- Minimize maintenance costs.
- Reduce down times.
- Improve parts life & reduce down time with proper seal replacements.

Call for a quote today!

INTENSIFIER

1. HP Cylinders
2. Seal Heads
3. HP Seals
4. Liners
5. Plungers
6. Hydraulic Head
7. HSEC Nut
8. Jacking Bolts
9. Hydraulic Cylinder
10. Proximity Switch
11. Piston Assembly
12. Hydraulic Seal Cartridge
13. Hydraulic Seal Retainer
14. O-rings
15. Backup Ring
16. Retaining Ring

HIGH PRESSURE SYSTEM

34. HP Bent Tubing
35. Attenuator
36. N.O. Valve
37. Seals
38. Stem & Seat
39. HP Fittings
40. Transducer

MOTOR/PUMP

17. Bearing Grease
18. Noise
19. Vibration
20. Leaks

LOW PRESSURE SYSTEM

41. Water Filters
42. Check Valves
43. Relief Valve
44. Booster Pump
45. Hoses
46. Pressure Switches
47. Pressure Gauges

ELECTRICAL

21. Display Function
22. Power Supply Test
23. Voltage Check
24. Cable Inspection

HYDRAULIC

25. Piston Pump
26. Recirculation Pump
27. Compensators
28. High Pressure Relief Valve
29. Low Pressure Relief Valve
30. Pressure Gauge
31. Main Relief Valve
32. Directional Valve
33. Hoses & Fittings

COOLING

48. Modulating Valve
49. Heat Exchanger
50. Temperature Gauge
51. Hoses
52. Temperature Sensor

CUTTING HEADS

Autoline™, IDE™ & Aqualine™

53. Actuator
54. N.C. Valve Body
55. Seals
56. Stem & Seat
57. Nozzle Tube
58. Wear Insert
59. Orifice
60. Focus Tube

ABRASIVE FEEDERS AND VESSELS

Feedline V, Feedline Precision, ADS 500 & 2,000 LB.

61. Abrasive Hopper
62. Metering System
63. Wear Insert
64. Transfer Hoses
65. Abrasive Output



TABLE OF CONTENTS

CUTTING HEADS

Autoline® PRO Assembly	12
IDE® PRO Assembly	12
Autoline® II Assembly	12
IDE® II Assembly	13
Autoline® I Assembly	13

CUTTING HEAD REPLACEMENT PARTS

Autoline® Caps	17
Autoline® Bodies	17
Autoline® Wear Inserts	17-18
Autoline® PRO Wear Inserts	18
Autoline® Spare Parts Kits	18
Abrasive Feed Tube Adapters	19
Abrasive Feed Tube Assembly	19
Autoline® Knob Retainers	19
Autoline® Abrasive Guard	19
IDE® Retaining Nut	20
Collet	20
HP Short Stop Adapter Assembly.....	20

ORIFICES - ABRASIVE, WATER ONLY & FOODgrade™

Autoline® I & Autoline® II Diamond	22
Water Only Diamond & Sapphire	23
UHP Water Only Diamond	24
FOODgrade™ Diamond	25

FOCUSING TUBES

Roctec 100	26
Roctec IRWJ-200	26
Roctec 500	26
PRO® Series Indexed	26

PNEUMATIC CONTROL VALVES

HP Pneumatic Valve/Actuator Assembly	28
UHP Pneumatic Valve/Actuator Assembly	28

PNEUMATIC CONTROL VALVE REPLACEMENT PARTS

HP Repair Kits	29
UHP Repair Kits	29
Actuator Tool Kit	30
Seal Tool Kit	30
Solenoid Valve	30
HP Pneumatic Valve Bodies	30
UHP Pneumatic Valve Bodies	31
HP Actuators	31
UHP Actuators	31
Backup Rings	32
HP Nozzle Nut	32
Valve Gland	32
Compression Spring	32
HP Collar	33
Adapters	33
Coupling Pipe	33
HP Bushing Assembly	33
HP Gland - Anti-Vibration	33

CUTTING HEAD NOZZLE TUBES

3/8 High Pressure	34
3/8 High Pressure/Nozzle Nut	34
3/8 High Pressure/Nozzle Nut/HP Connection	34
9/16 High Pressure	35
9/16 High Pressure/Nozzle Nut	35
3/4 High Pressure for IDE Cutting Head	35
3/4 UHP Short Stop Filter Connection	36

ABRASIVE METERING SYSTEMS

EZ Feedline®	38
Feedline Precision®	38
Feedline V®	38
PVC Tubing	38



***TEXT SHOWN IN BLUE DENOTES STREAMLINE PRO® 90,000 PSI ULTRA HIGH PRESSURE PARTS**

MEASUREMENT CALCULATOR:

.25 = 1/4 inch	.56 = 9/16 inch
.38 = 3/8 inch	.75 = 3/4 inch

TABLE OF CONTENTS

HIGH PRESSURE FITTINGS

HP Coupling Assembly	40
UHP Coupling Assembly	40
HP Elbow Assembly	40
UHP Elbow Assembly	40
HP Tee Assembly	41
UHP Tee Assembly	41
HP Cross Assembly	41
UHP Cross Assembly	41
HP Bushing Assembly	42
UHP Bushing Assembly	42
HP Collar Assembly	42
UHP Collar Assembly	42
HP Gland	43
UHP Gland	43
HP Adapter Cone	43
UHP Adapter Cone	43
HP Plug	44
UHP Plug	44
HP Hand Valve, Straight	44
UHP Hand Valve, Straight	44
HP Hand Valve, 90 Degree	45
UHP Hand Valve, 90 Degree	45
HP Hand Valve, 3 Way, 1 Press	45

TUBING - STAINLESS STEEL

HP Tube 66,000 psi, Coned & Threaded	46
UHP Tube 100,000 psi, Coned & Threaded	47
HP Hose Ferrule	48
HP Conduit	48

NOTE: HP & UHP STAINLESS STEEL BENT TUBING IS INTENSIFIER MODEL SPECIFIC. PLEASE CONTACT KMT GENUINE PARTS CUSTOMER SERVICE FOR ORDERING ASSISTANCE @ 800-991-4225.

NOTE: HP & UHP COILS ARE ROBOT SPECIFIC. PLEASE CONTACT KMT GENUINE PARTS CUSTOMER SERVICE FOR ORDERING ASSISTANCE @ 800-991-4225.

HP & UHP STAINLESS STEEL STRAIGHT TUBING IS SOLD IN RANDOM LENGTHS. PLEASE CONTACT KMT CUSTOMER SERVICE FOR ORDERING ASSISTANCE @800-991-4225.

SWIVEL JOINT ASSEMBLIES

Repair Kits	49
UHP Repair Kits	49
HP Spindle	50
UHP Spindle	50
HP Straight	50
UHP Straight	50
HP 90 Degree	51
UHP 90 Degree	51
HP Cap Assembly	51
HP Body - Straight	51
UHP Body - Straight	51
HP Body - 90 Degree.....	52
UHP Body - 90 Degree	52
HP Bushing	52
HP Thrust Bearing	52
UHP Thrust Bearing	52
HP Seal Assembly	52
UHP Seal Assembly	52
HP Clamp Collar	52
HP Thrust Washer	52

INLINE WATER FILTERS

HP Filter Element	53
UHP Filter Element	53
HP Water Filter Assembly	53
UHP Water Filter Assembly	54
Bayonet Nipple	54

***TEXT SHOWN IN BLUE DENOTES
STREAMLINE PRO® 90,000 PSI
ULTRA HIGH PRESSURE PARTS**



TABLE OF CONTENTS

TOPWORKS REPLACEMENT PARTS

Hydraulic Piston Repair Kit	57
HP Cylinder Repair Kits	57
HP Seal Assembly	58
UHP Seal Assembly	58
HP Cylinder Seal Assembly	59
Proximity Switch Kits	59
Hydraulic Cylinder	60
Hydraulic Cylinder Heads	60
HP Pump Plungers	61
HP Cylinder Liners	61
UHP Cylinder Liners	61
HP Backup Rings	62
UHP Backup Rings	62
Hydraulic Cartridge Seal Assembly	62
Hydraulic Piston Assembly	62
Hydraulic Piston Seal Assembly	63
Packing Rings	63
Hydraulic Piston Bearing	63
HP Cylinders	63-64
UHP Cylinders	64
HP Cylinder Head	64
HP Cylinder Assembly	65
HP Cylinder Nuts	65
HP Packing Follower	65
Bushing Retainer Flange	66
Retaining Ring	66
Jackbolt	66
HP Attenuator Assembly	66

SEALING HEAD REPLACEMENT PARTS

HP Check Valve Repair Kits	68
UHP Check Valve Repair Kits	69
HP Seal Assembly	69
Check Valve - LP/HP Pump	69
Check Valve Body	69
HP Sealing Head Assembly	70
UHP Sealing Head Assembly	70
HP Sealing Head	71
UHP Sealing Head	71
HP Check Valve Gland Nuts	72
UHP Check Valve Glands Nuts	72
HP Sealing Head Spacers	72

LOW PRESSURE WATER SYSTEMS

Filter Housing Assembly	75
Filter Element	75
Filter Strainer	75
Vane Pumps	75
Water Modulating Valve	75

HYDRAULIC SYSTEM

Filter Element	76
Pressure Gauge	76
Knob Adjuster - Pressure Relief	76
Directional Control Valve Assembly	76

O-RINGS

Sealing Head	76
Topworks	77
Inline Filter	77
Pneumatic Valves	78
Cutting Heads	78

***TEXT SHOWN IN BLUE DENOTES
STREAMLINE PRO® 90,000 PSI
ULTRA HIGH PRESSURE PARTS**



TABLE OF CONTENTS

HOSES

Polyurethane Tubing	79
Push-on Hose	79
PVC Tubing	79
Flexible Tubing	79

GAUGES

Hydraulic Gauges	79
Water Pressure Gauges	79

ELECTRICAL

Proximity Switch Kits	80
Conduit	80
Solenoid Valves	80
Output Module	80
Inlet Pressure Switch	80
Directional Control Valve Assembly	80-81
Light Bulbs	81
Pressure Transducers	81
Pico Fuse	81
Hose - Ferrule	81

MAINTENANCE TOOLS - TOPWORKS

Cylinder Wrench	82
HP Seal Removal Tool	82
Hydraulic Tensioner Assembly	82
Plate Glass Pane	82
Cylinder Clamp	82
Plunger Removal Tool	82
Crowfoot Wrench	82
Vee Block Cradle	82
HP Seal Removal Tool Stand	82
End Cap Wrench	83
Emory Cloth	83

MAINTENANCE TOOLS - LUBRICANTS

Pure Goop Thread Lubricant	83
NLGI-2 Swivel Grease	83
FML-2 Grease	83
Super-O-Lube O-Ring Grease	83
Threadlocker Adhesive	83
Threadlocker Primer	83
JL-M Thread Lubricant	83

MAINTENANCE TOOLS - CONING & THREADING

Tool Kits	84
Blades	84
Retainers	84
Tube Vise	84
HP Coning Tool Assembly	85
HP Threading Tool Assembly	85
Threading Die	86
Collet	86

MAINTENANCE TOOLS - PNEUMATIC VALVES

Seal Tool Kits	86
Kit - Actuator Assembly	86
Seal Positioning Tool	86

MANUALS

Operations & Maintenance Manual for SL-V 30	87
Operations & Maintenance Manual for SL-V 50	87
Operations & Maintenance Manual for SL-V 60	87
Operations & Maintenance Manual for SL-V 75	87
Operations & Maintenance Manual for S-30	87
Operations & Maintenance Manual for PRO® 60	87
Operations & Maintenance Manual for SL-V 15	87
Operations & Maintenance Manual for S-50	87
Operations & Maintenance Manual for PRO® 125	87

***TEXT SHOWN IN BLUE DENOTES
STREAMLINE PRO® 90,000 PSI
ULTRA HIGH PRESSURE PARTS**



PART NUMBER/PAGE NUMBER INDEX

PART #	PG. #	PART #	PG. #	PART #	PG. #	PART #	PG. #	PART #	PG. #	PART #	PG. #
05007786	66	05108774	84	05120258	85	10078509	43	10105880	46	10149052	82
05013735	34	05108782	84	05121512	22	10078525	40	10106417	71	10154680	52
05015060	63	05108790	84	05122742	85	10078590	41	10106722	75	10177806	78
05017553	76, 80	05108808	84	05122759	85	10078608	43	10107910	72	10177855	31
05026281	83	05108816	84	05123385	58	10078640	40	10110393	69	10178614	69
05027172	59	05108824	84	05125836	79	10078699	43	10116333	43	10181105	35
05034764	60	05108832	85	05127584	59, 80	10078715	33, 42	10119030	45	10184760	28
05034772	60	05108840	85	05130091	62	10078749	45	10126928	26	10186153	48, 80
05034798	66	05108857	85	05130927	26	10078772	44	10126936	26	10187052	76
05034855	62	05108865	85	05131347	48, 81	10078780	40	10126969	26	10187250	32
05038690	75	05108873	85	05132253	62	10078863	44	10126982	26	10189181	30
05039771	61	05108881	85	05133335	68	10078889	44	10134682	51	10189553	31
05044532	79	05108899	86	05135827	17	10078905	40	10134690	52	10193100	35
05045497	76, 79	05108915	86	05136031	34	10078913	33, 43	10134708	50	20412569	22
05049689	76	05108964	86	05136098	22	10079002	45	10134716	51	20412815	75
05049853	76	05108972	86	05136312	63	10079028	40	10138402	34	20412890	87
05049994	62	05109079	22	05139506	79	10079051	40	10138410	34	20413039	87
05050216	81	05109087	22	05140157	Obsolete	10079119	42	10138428	34	20413062	87
05051891	26	05109095	22	05140751	80	10079168	41	10138436	34	20413096	87
05054119	32	05109103	22	05144191	77	10079259	44	10138444	34	20414862	63
05059688	65	05109111	22	05144357	71	10079275	45	10138451	34	20414880	60
05059712	63	05109129	22	05144506	61	10079291	43	10138469	34	20416445	60
05063847	22	05109137	22	05144514	60	10079424	42	10138485	35	20421272	79
05066139	82	05109814	84	05144555	61	10079432	42	10138493	35	20422243	58
05067350	86	05109822	84	05144647	64	10079457	42	10138501	35	20422970	48, 81
05069703	28	05109830	84	05144597	72	10079465	41	10138519	35	20422988	48, 80
05071659	75	05109871	85	05144688	70	10079473	42	10138527	35	20425545	87
05073820	17	05109889	85	05144696	72	10079481	41	10138535	35	20427648	30
05076955	17	05109897	85	05145099	66	10079523	44	10138584	34	20427739	28
05076963	38, 79	05110531	53	05146576	62	10079531	40	10138592	34	20427747	68
05076971	17	05112057	46	05146584	62	10079580	33, 42	10138600	34	20428126	26
05076989	19	05112537	22	05146618	82	10079614	40	10138618	34	20431076	64
05077029	22	05114137	53	05146964	29	10079655	42	10138634	34	20434777	63
05077037	22	05114897	22	05149703	58	10083897	48, 81	10138642	34	20436198	23
05077078	78	05114905	22	05149711	58	10084440	83	10138659	34	20437164	76, 81
05077300	22	05114913	22	10067189	83	10084713	52	10138667	35	20439964	86
05077367	18	05114921	22	10069326	46	10087385	83	10138675	35	20442434	17
05078530	13	05115951	57	10074367	76	10090280	46	10138683	35	20443831	79
05078712	19	05115969	57	10074409	77	10091866	75	10138691	35	20445476	78
05081518	78	05115977	57	10074565	78	10093573	43	10138709	35	20448541	22
05084504	22	05115985	68	10074599	77	10094175	46	10138717	35	20448625	22
05086905	48, 80	05115993	57	10074714	78	10094183	46	10138725	35	20451227	26
05087168	19	05116009	49	10074870	78	10094191	46	10138824	28	20452309	26
05087713	77	05116017	29	10074904	76	10094647	52	10139426	26	20452956	43
05092887	78	05116025	29	10074920	77	10094704	46	10144590	59	20452959	42
05097928	26	05116595	72	10075000	77	10097228	41	10146082	76	20452962	43
05097936	26	05116652	26	10077030	33	10097533	45	10146363	80	20452965	42
05097944	26	05116769	70	10078038	41	10097822	63	10148674	82	20452968	41
05101753	22	05116777	72	10078129	43	10097855	64	10149029	83	20452971	41
05104187	76	05117528	26	10078145	40	10097871	71	10149037	83	20453064	18
05104930	78	05117940	63	10078244	44	10098366	65	10105443	46	20453082	18
05108741	84	05117965	63	10078301	86	10100782	75			20453115	41
05108758	84	05119151	61	10078426	42	10102226	33			20453121	43
05108766	84	05120092	62	10078459	43					20453124	42

PART NUMBER/PAGE NUMBER INDEX

PART #	PG. #	PART #	PG. #	PART #	PG. #	PART #	PG. #	PART #	PG. #	PART #	PG. #
20453127	44	20476495	82	20480940	54	20487868	83	49888977	23	80079239	83
20453130	44	20477023	40	20480977	35	20487975	47	49888985	23	80082191	83
20453136	44	20477256	87	20481005	70	20488720	49	49888993	23	80084403	68
20453553	53	20477366	26	20481009	71	20489074	35	49895584	78	80086622	62
20453688	64	20477382	26	20481026	54	20489092	35	49899602	50	80086663	22
20453925	59, 80	20477386	26	20481140	81	20489107	47	72101354	35	80086671	22
20453934	59, 80	20477395	26	20481210	26	20489115	47	72103361	47	A225910	34
20453949	12	20477460	82	20481407	12	20489495	68	72103379	47	A225911	34
20453952	17	20477469	82	20481408	12	20489761	47	72103386	47	A225912	34
20453958	17	20477489	82	20481409	12	20490760	26	72103535	47	A22593	34
20453964	19	20477505	69	20481410	12	20490768	26	72103733	47	A22594	34
20453973	19	20477518	29	20481411	12	20490843	50	72104402	47	A22595	34
20453976	19	20477521	29	20481412	12	20490851	50	72105096	38	A22596	34
20454108	12	20477623	50	20481413	12	20490859	52	72108319	47	A2259800	34
20454129	18	20477660	40	20481414	12	20491098	51	72110531	69	A2260003	23
20454198	84	20477685	40	20481415	12	20491603	61	72110945	61	A2260004	23
20454201	84	20477709	40	20481416	12	20492123	66	72110961	71	A2260005	23
20454339	18	20477730	40	20481418	12	20492248	87	72110979	70	A2260006	23
20454342	20	20477738	40	20481660	72	20493999	47	72113680	25	A2260007	23
20454345	20	20477836	45	20481704	24	20494983	83	72113688	25	A2260008	23
20454351	32	20477950007	13	20481705	24	20497106	36	72113753	Obsolete	A2260009	23
20454354	28	20477950008	13	20481706	24	20497504	38	72117819	69	A2260010	23
20454363	20	20477950009	13	20481707	24	20497767	61	72118339	75	A2260011	23
20454366	20	20477950010	13	20481708	24	20498314	66	72119529	63	A2260012	23
20455329	35	20477950011	13	20481709	24	49830904	33	72119536	64	A2260013	23
20455374	41	20477950012	13	20481710	24	49832199	83	72119544	64	A2260014	23
20455377	40	20477950013	13	20481711	24	49832678	Obsolete	72120023	63	A2260015	23
20455809	40	20477950014	13	20481712	24	49832801	Obsolete	72121850	64	A2260016	23
20455812	41	20477950016	13	20481713	24	49833114	86	72121858	64	A2260018	23
20455821	40	20477950018	13	20481714	24	49833593	26	72122072	43	A2260019	23
20455824	41	20477959007	13	20481715	24	49834716	75	72125203	68	A2260020	23
20456913	53	20477959008	13	20481716	24	49835390	26	72129713	49	A2260022	23
20458242	18	20477959009	13	20481717	24	49836786	23	72132350	25	AF503473	53
20464647	35	20477959010	13	20481718	24	49837206	Obsolete	72132358	25	AP1412671	65
20467135	58	20477959011	13	20481719	24	49837933	26	72133175	42	AV317274	72
20467883	79	20477959012	13	20481720	24	49837941	26	72133183	42	B2841	32
20467981	44	20477959013	13	20481721	24	49838478	81	72133209	42	B3393	32
20468014	44	20477959014	13	20481722	24	49839913	26	72133224	42	BF103473	53
20468568	44	20477959016	13	20484737	81	49885361	38, 79	72133232	42	BJ201388	52
20468593	45	20477959018	13	20484961	82	49885866	81	72133250	42	BJ701288	51
20468610	45	20478649	47	20485224	87	49887094	75	72133266	43	BV118874	69
20468617	31	20478751	47	20485968	83	49888035	30, 80	72133349	43	BV610174	69
20468634	28	20479022	31	20486133	26	49888852	23	72135447	69	BV701184	32
20468830	47	20479050	87	20486151	26	49888860	23	72136231	25	CJ200988	53
20470475	30, 86	20479499	58	20486158	26	49888878	23	72136249	25	CJ201288	51
20473479	64	20479503	64	20486166	26	49888886	23	72136256	25	CJ211388	50
20474154	31	20479524	71	20486762	38	49888894	23	80070352	66	CJ218088	50
20474333	61	20479589	18	20486952	50	49888902	23	80070519	46	CJ218188	51
20475871	31	20480087	70	20486976	51	49888910	23	80073646	65	CJ311388	51
20475882	32	20480113	70	20487002	52	49888928	23	80074057	68	CJ318088	50
20475916	54	20480359	28	20487241	36	49888936	23	80074446	35	CJ401288	52
20475944	54	20480707	12	20487249	36	49888944	23	80075252	26	CJ418088	51
20475956	52	20480715	17	20487257	36	49888951	23	80075781	22	CJ501288	50
20476132	82	20480732	17	20487273	36	49888969	23	80077795	30, 86	DJ301288	52
								80078330	82	SKJA266	53
										SKJA287	54



CUTTING HEADS

Precise alignment of cutting head components is what ensures maximum component life and greatest productivity. KMT cutting heads are precision manufactured and precision aligned in our laboratory using proprietary alignment techniques to ensure the very best cutting performance. Dollar for dollar, KMT delivers the best value for your cutting needs on any waterjet system.

KMT Cutting Heads are:

- **The result of over 40 years of cutting experience – longer than any other manufacturer**
- **Rated best in the industry by independent university testing**
- **The best solution for your cutting needs – available in multiple orifice sizes**

For maximum performance and value on any KMT pump and those manufactured by other OEMs, install a KMT cutting head.

DESCRIPTION

PART No.

AUTOLINE® PRO ASSEMBLY
 90,000 psi, .75 UHP
 (Orifice Assembly & Focusing Tube Not Included)

20480707



IDE® PRO ASSEMBLY
 90,000 PSI

Diamond Orifice

- .07
- .08
- .09
- .10
- .11
- .12
- .13
- .14
- .15
- .16
- .18

- 20481407
- 20481408
- 20481409
- 20481410
- 20481411
- 20481412
- 20481413
- 20481414
- 20481415
- 20481416
- 20481418



AUTOLINE® II ASSEMBLY
 60,000 psi

.030 wear insert, .38 HP
 (Diamond & Focusing Tube Not Included)

20453949

.043 wear insert, .38 HP
 (Diamond & Focusing Tube Not Included)

20454108



DESCRIPTION

PART NO.

IDE® II ASSEMBLY

60,000 psi

Diamond Orifice

0.007	20477959007
0.008	20477959008
0.009	20477959009
0.010	20477959010
0.011	20477959011
0.012	20477959012
0.013	20477959013
0.014	20477959014
0.016	20477959016
0.018	20477959018



Diamond Orifice & Short Stop Filter

0.007	20477950007
0.008	20477950008
0.009	20477950009
0.010	20477950010
0.011	20477950011
0.012	20477950012
0.013	20477950013
0.014	20477950014
0.016	20477950016
0.018	20477950018



AUTOLINE® I ASSEMBLY

60,000 psi, .030 wear insert, .38 HP
(Diamond & Focusing Tube Not Included)

05078530



CUTTING HEAD ASSEMBLIES

REPLACEMENTS PARTS

ORIFICES

**FOR COMPLETE CUTTING HEAD ASSEMBLIES, PLEASE
CALL KMT CUSTOMER SERVICE AT 800-826-9274.**



CUTTING HEAD REPLACEMENT PARTS



KMT's Autoline® & IDE® cutting heads include patented designs, engineered and manufactured to deliver the best cutting performance in the industry. Ensure you cut with the greatest value & speed by using KMT Genuine Parts.

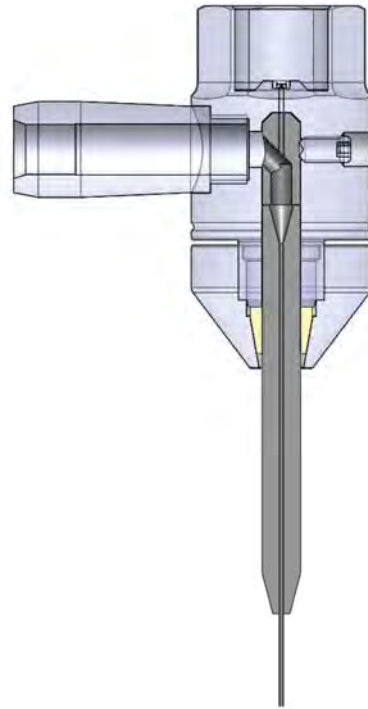

AUTOLINE® CUTTING HEAD ASSEMBLY COMPONENTS

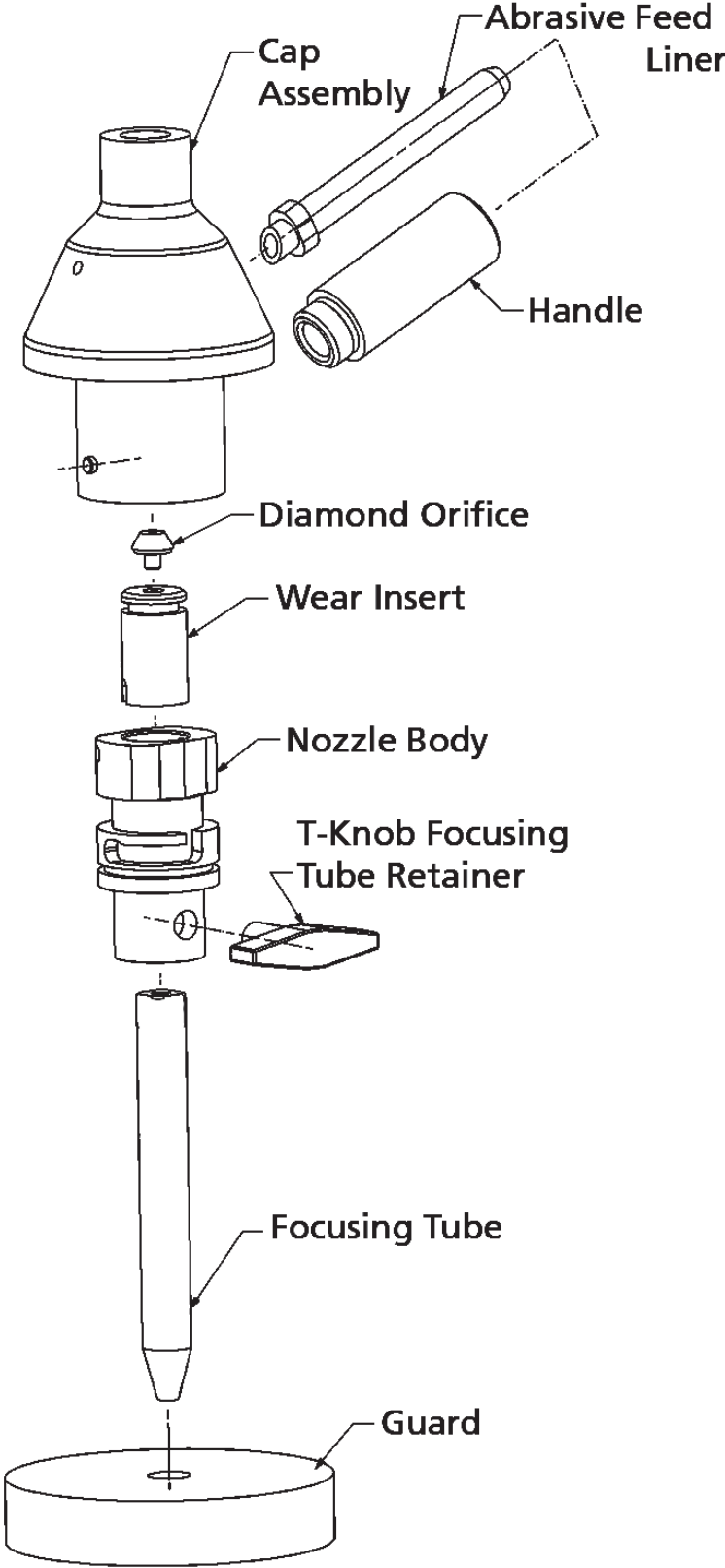

DESCRIPTION

PART No.

CAP

AutoLine® I - 60,000 psi, .38 HP

05076971

AutoLine® II - 60,000 psi, .38 HP

20453952

Autoline® PRO - 90,000 psi, .75 UHP

20480732

PART FITS ON:



BODY

AutoLine® I - 60,000 psi

05073820

AutoLine® II - 60,000 psi

20453958

Autoline® PRO - 90,000 psi

20480715



WEAR INSERTS

AutoLine® I - 60,000 psi

.030, 45° Inlet, Tungsten Carbide

05076955

.043, 45° Inlet, Tungsten Carbide

05135827

.052, 45° Inlet, Tungsten Carbide

20442434

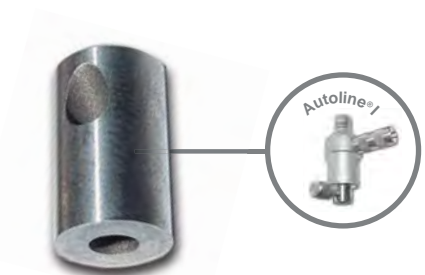

CUTTING HEAD REPLACEMENT PARTS

ORIFICES

FOCUSING TUBES

DESCRIPTION

PART No.

PART FITS ON:

WEAR INSERTS

AutoLine® II - 60,000 psi

.030, 25° Inlet

20453064

.043, 25° Inlet

20453082

.054, 25° Inlet

20454339

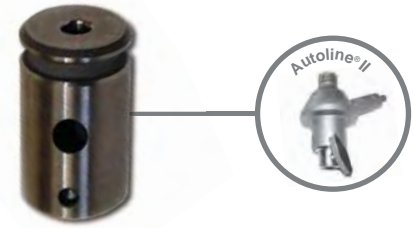

Autoline® PRO - 90,000 psi

20458242

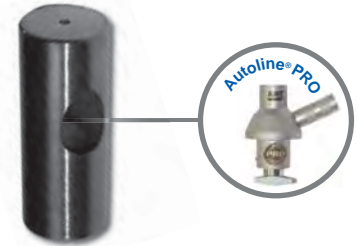

SPARE PARTS KITS

AutoLine® I - 60,000 psi

Kit includes the setscrew and o-rings to service any AutoLine® I assembly.

05077367

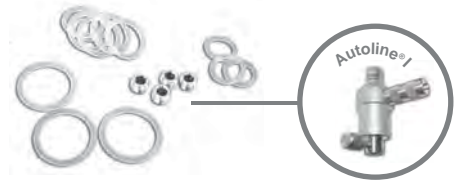

AutoLine® II - 60,000 psi

Kit includes the setscrew and o-rings to service any AutoLine® II assembly.

20454129

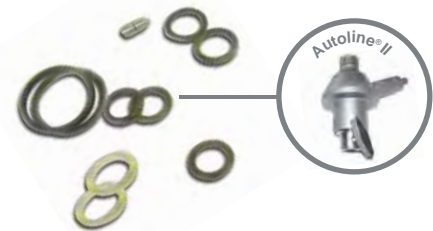

AutoLine® PRO - 90,000 psi

Kit includes the setscrew and o-rings to service any AutoLine® PRO assembly.

20479589

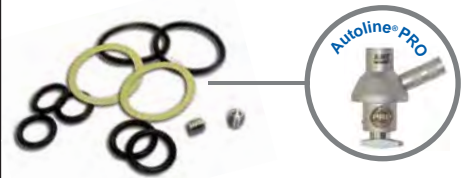

DESCRIPTION

PART No.

ABRASIVE FEED TUBE ADAPTERS

AutoLine® I, Stainless Steel

05076989

Autoline® II & Autoline® PRO,
Stainless Steel

20453973

PART FITS ON:



ABRASIVE FEED TUBE ASSEMBLY

AutoLine® II and AutoLine® PRO

20453964

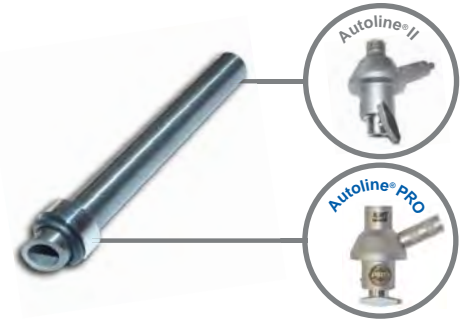

KNOB RETAINER

Autoline® I, Stainless Steel

05078712

Autoline® II and Autoline® PRO, T-Handle, Stainless Steel

20453976



ABRASIVE GUARD

Autoline®, Autoline® II and Autoline® PRO

05087168



CUTTING HEAD REPLACEMENT PARTS

ORIFICES

FOCUSING TUBES

DESCRIPTION

PART No.

IDE® RETAINING NUT

.38, Stainless Steel
Used with IDE® II and IDE® PRO cutting heads.

20454342

PART FITS ON:

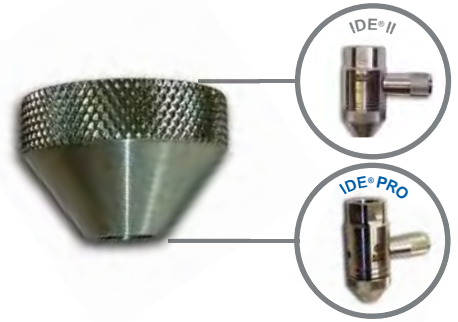

FOCUSING TUBE RETAINING COLLET

.373 ID, Brass
Retaining ring for IDE® II and IDE® PRO cutting heads.

20454345

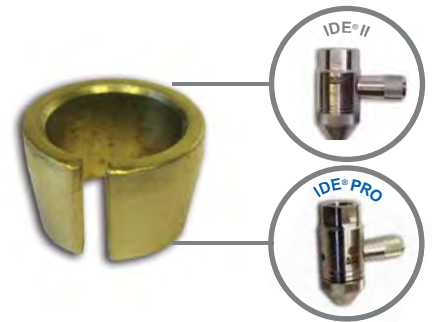

SHORT STOP ADAPTER ASSEMBLY

60,000 psi. Required when incorporating an IDE® II cutting head into an existing system with a KMT pneumatic valve.

.38 M x .25 F, High Pressure Tubing

20454363

.38 M x .38 F, High Pressure Tubing

20454366





ORIFICES & FOCUSING TUBES

KMT's proprietary diamond orifice mounting & alignment processes deliver a truly superior cutting stream, resulting in longer focus tube life and faster cutting. All of our diamond abrasive cutting orifices are tested in-house to assure the KMT quality you expect.

For water-only cutting try the KMT FOODgrade™ diamond orifice with a longer coherent cutting stream, exclusively from KMT. Call for details.

KMT offers focusing tubes in a variety of materials, prices and sizes to match your cutting needs from leading manufacturers Kennametal and Ceratizit.

DESCRIPTION

PART NO.

ORIFICES FOR ABRASIVE CUTTING

Diamond, 60,000 psi, Autoline® I & II
For True Alignment & Maximum Performance.

.004 (.102)	20448625
.007 (.178)	05063847
.008 (.203)	05112537
.009 (.229)	05084504
.010 (.254)	05077029
.011 (.279)	05101753
.012 (.305)	05077300
.013 (.330)	05136098
.014 (.356)	05077037
.015 (.381)	80075781
.016 (.406)	05121512
.018 (.457)	05114905
.019 (.482)	80086663
.020 (.508)	05114897

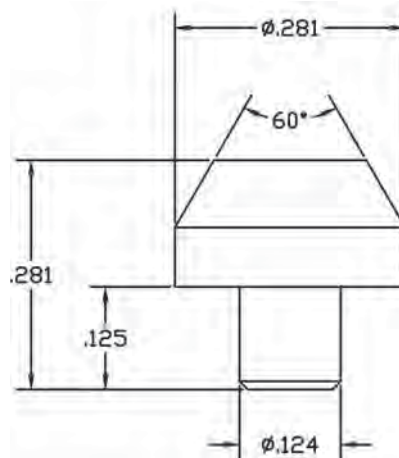

ORIFICES FOR ABRASIVE CUTTING

Sapphire, 60,000 psi, Autoline® I & II

.007 (.178)	05109079
.008 (.203)	05109087
.009 (.229)	05109095
.010 (.254)	05109103
.011 (.279)	05109111
.012 (.305)	05109129
.013 (.330)	20412569
.014 (.356)	05109137
.016 (.406)	20448541
.018 (.457)	05114913
.019 (.482)	80086671
.020 (.508)	05114921

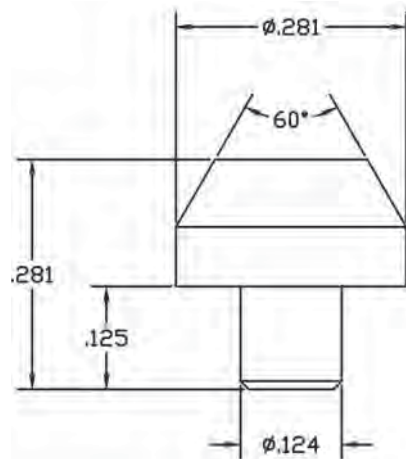

DESCRIPTION

PART No.

ORIFICES FOR WATER ONLY CUTTING

Diamond, 60,000 psi

.003 (.076)	49888852
.004 (.102)	49888860
.005 (.127)	49888878
.006 (.152)	49888886
.007 (.178)	49888894
.008 (.203)	49888902
.009 (.229)	49888910
.010 (.254)	49888928
.012 (.305)	49888936
.013 (.330)	49836786
.014 (.356)	49888944
.015 (.381)	49888951
.016 (.406)	49888969
.018 (.457)	49888977
.019 (.483)	20436198
.020 (.508)	49888985
.022 (.559)	49888993

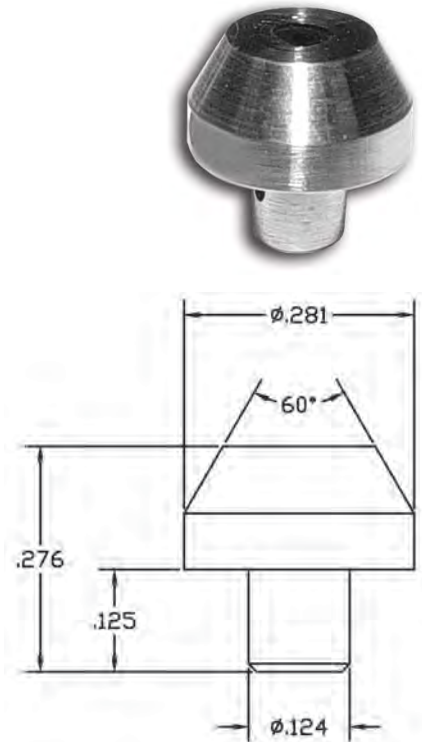

ORIFICES FOR WATER ONLY CUTTING

Sapphire, 60,000 psi

.003 (.076)	A2260003
.004 (.102)	A2260004
.005 (.152)	A2260005
.006 (.178)	A2260006
.007 (.178)	A2260007
.008 (.203)	A2260008
.009 (.229)	A2260009
.010 (.254)	A2260010
.011 (.279)	A2260011
.012 (.305)	A2260012
.013 (.330)	A2260013
.014 (.356)	A2260014
.015 (.381)	A2260015
.016 (.406)	A2260016
.018 (.457)	A2260018
.019 (.483)	A2260019
.020 (.508)	A2260020
.022 (.559)	A2260022



ORIFICES - WATER ONLY

FOCUSING TUBES

PNEUMATIC VALVES

DESCRIPTION

PART NO.

ORIFICES FOR WATER ONLY CUTTING

Diamond, 90,000 psi

.004 (.102)	20481704
.005 (.127)	20481705
.006 (.152)	20481706
.007 (.178)	20481707
.008 (.203)	20481708
.009 (.229)	20481709
.010 (.254)	20481710
.011 (.279)	20481711
.012 (.305)	20481712
.013 (.330)	20481713
.014 (.356)	20481714
.015 (.381)	20481715
.016 (.406)	20481716
.017 (.432)	20481717
.018 (.457)	20481718
.019 (.483)	20481719
.020 (.508)	20481720
.021 (.533)	20481721
.022 (.559)	20481722

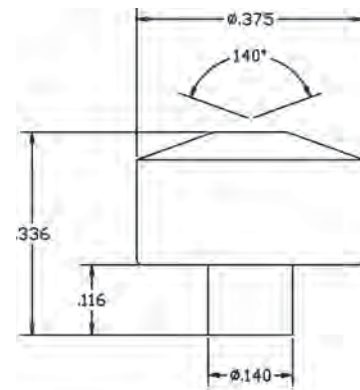

DESCRIPTION

PART No.

FOODgrade™ ORIFICES FOR WATER ONLY CUTTING
Diamond, 60,000 psi

.005 (.152)	72113688
.006 (.178)	72132350
.007 (.178)	72113680
.008 (.203)	72132358
.009 (.229)	72136231
.010 (.254)	72136249
.011 (.279)	72136256

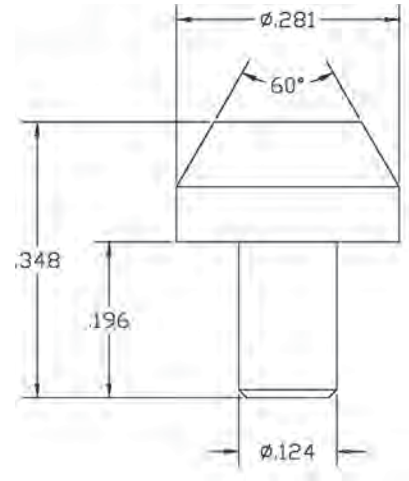

WATER ONLY ORIFICE COMPARISONS

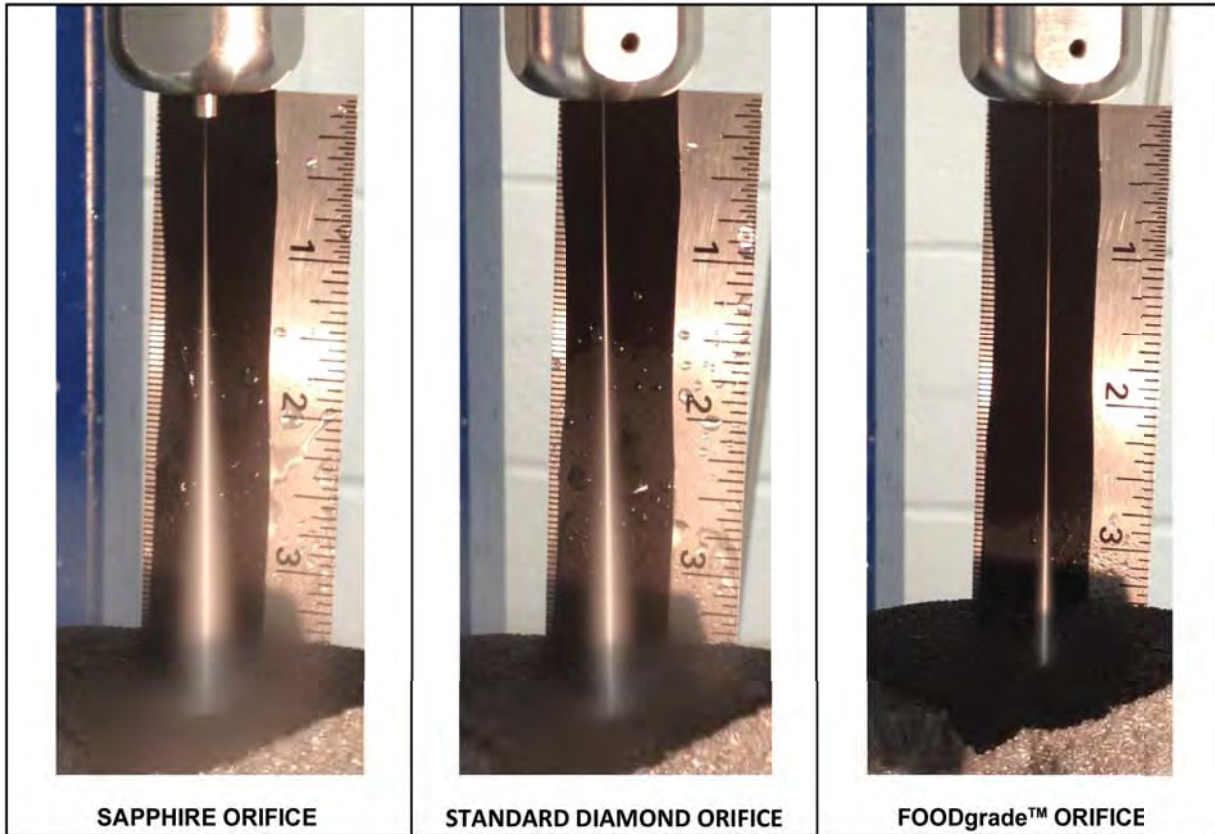

SAPPHIRE ORIFICE

STANDARD DIAMOND ORIFICE

FOODgrade™ ORIFICE

ORIFICES - WATER ONLY

FOCUSING TUBES

PNEUMATIC VALVES

DESCRIPTION

PART No.

DESCRIPTION

PART No.

FOCUSING TUBES

ROCTEC® 100

.021 x 2.0	10139426
.021 x 3.13	20451227
.025 x 3.13	20452309
.030 x 3.13	10126969
.030 x 4.0	20428126
.036 x 3.13	80075252
.039 x 3.13	49833593
.040 x 3.13	49835390
.040 x 3.00 x 25D	20481210
.043 x 3.13	10126928
.052 x 3.13	05117528
.058 x 3.13	05051891
.063 x 3.13	10126936



ROCTEC® 500

.021 x 2.0	05097928
.030 x 3.13	05097944
.036 x 3.13	05116652
.043 x 3.13	05097936
.093 x 3.13	05130927



PRO® Series Indexed

The PRO® Series features the superior HyperTube® Index Design for longer, more uniform wear preventing "focusing tube blow-out".

.030 x 3.0	20477366
.030 x 4.0	20477382
.033 x 4.0	20490760
.040 x 3.0	20486133
.040 x 4.0	20486166
.043 x 3.0	20477386
.043 x 4.0	20477395
.045 x 3.0	20486151
.045 x 4.0	20486158
.048 x 4.0	20490768

HyperTube® Index Design



IRWJ-200

.020 x 3.0, IRWJ	49839913
.030 x 3.0, IRWJ	49837933
.040 x 3.0, IRWJ	49837941



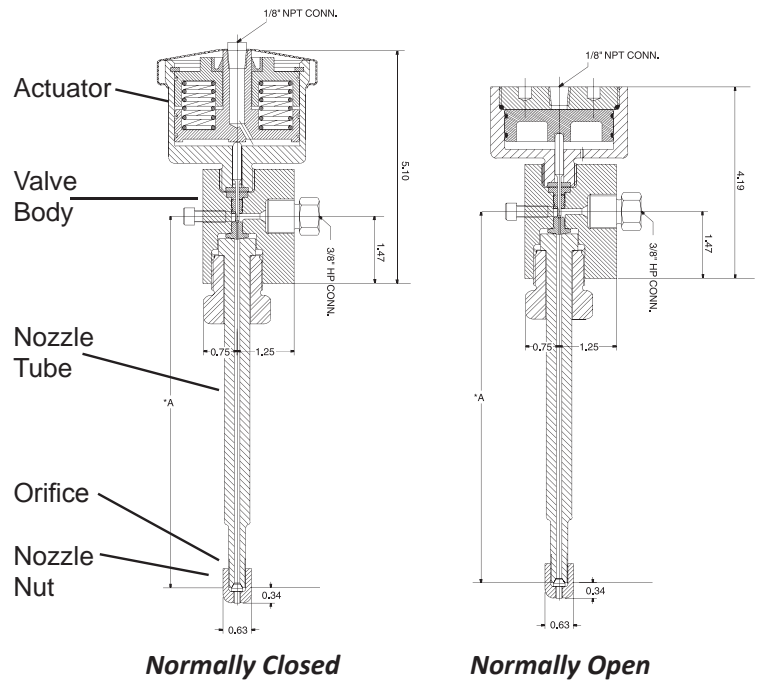
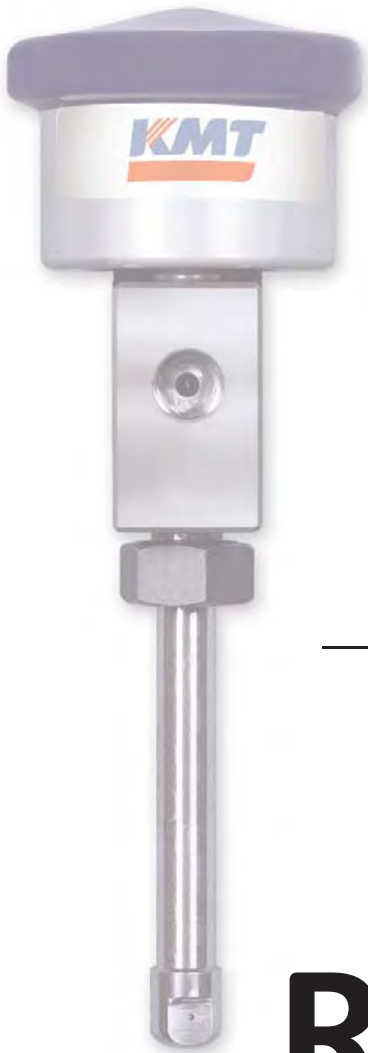

PNEUMATIC VALVES & REPLACEMENT PARTS

When you need reliability, speed and safety you turn to KMT. The newly designed Aqualine pneumatic valves from KMT Waterjet use an innovative seal and stem design to maximize life and deliver the greatest value. These valves enable longer production runs, resulting in increased output.

Designed to Perform Longer

The Aqualine Normally Open & Normally Closed (NO/NC) valves have very reliable and fast performance due to the 6 stainless steel springs which apply the force to open or close the valve. The re-designed valves have an improved stem design and specialized seals which provide a far better performance and enable increased production.

The dump valve safely relieves pressure during any waterjet operation. Using KMT Genuine Parts ensures that your dump valve operates reliably as designed.

KMT Genuine Parts
Your business is worth it.

DESCRIPTION

PART No.

**PNEUMATIC VALVE/
ACTUATOR ASSEMBLIES**

HP, 60,000 psi - N/O

10184760

HP, 60,000 psi - N/C

10138824

HP, 60,000 psi - N/C, IDE® Gland

20454354

UHP, 90,000 psi - N/C

20480359

HP, 60,000 psi - N/O
2-Port Dump valve, Solenoid valve,
Square body.

05069703

HP, 60,000 psi - N/O
3-Port Dump valve, Round body.

20427739

UHP, 90,000 psi - N/O
2-port Dump valve.

20468634

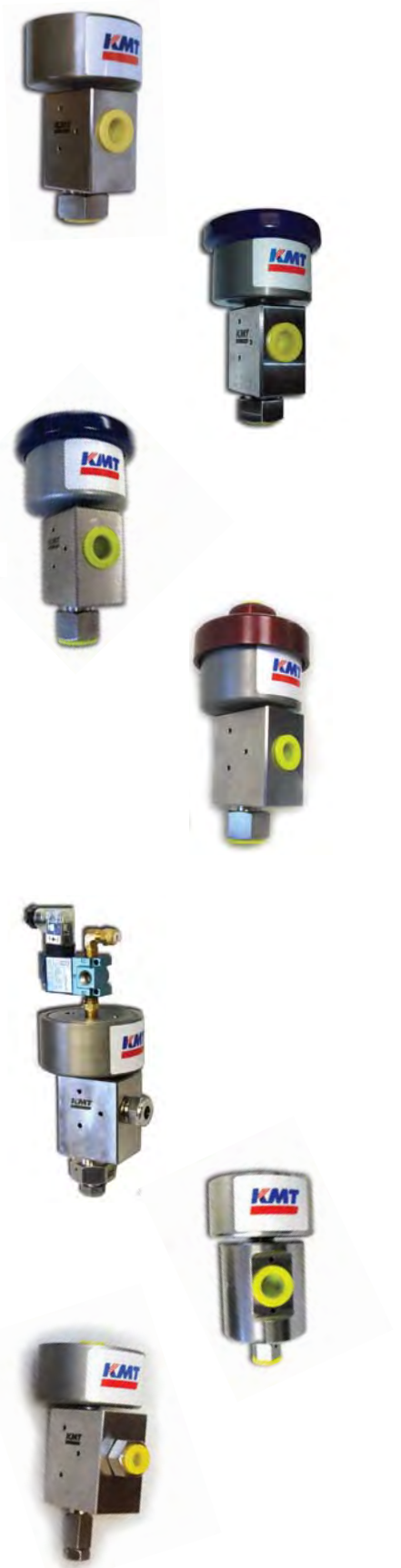

REPAIR KITS

HP Pneumatic Valve, N/O, 60,000 psi

Kit includes valve seat and stem, seal assembly, backup ring & o-rings required to service the valve and the actuator.

05116017

**HP Pneumatic Valve, N/C, 60,000 psi**

Kit includes valve seat and stem, seal assembly, backup ring & o-ring required to service the valve.

05116025

**HP Pneumatic Valve, N/C, Cold Weather Seal Assembly, 60,000 psi**

Kit includes valve stem and seat, CWS seal assembly, bronze backup ring and o-ring.

05146964

**UHP Pneumatic Valve, N/O, 90,000 psi**

Kit includes valve seat and stem, seal assembly, brass backup ring and o-rings required to service the valve and the actuator.

20477518

**UHP Pneumatic Valve, N/C, 90,000 psi**

Kit includes valve seat and stem, seal assembly, brass backup ring and o-ring required to service the valve.

20477521



DESCRIPTION

PART No.

TOOL KITS

N/C Actuator Assembly, 60,000/90,000 psi

Kit includes top and bottom protector tool, and snap ring pliers to service all HP and UHP, N/C pneumatic actuator assemblies.

80077795



Seal Tools, HP/UHP Pneumatic Valves

Used to service all HP and UHP pneumatic valves. Kit includes a seal push, positioning and installation tool.

20470475



Solenoid Valve - 24V DC

49888035



HP PNEUMATIC VALVE BODIES

2-Port, (2) .38, (1) .56, Stainless Steel, 60,000 psi

For use on all KMT 2-port HP pneumatic valves.

10189181



3-Port, .38, Stainless Steel, 60,000 psi

For use on all KMT 3-port HP pneumatic dump valves.

20427648



DESCRIPTION

PART No.

UHP PNEUMATIC VALVE BODIES

Dump Valve, Stainless Steel, 90,000 psi
 For use on all KMT UHP pneumatic dump valves.

20468617

Stainless Steel, 90,000 psi
 For use on all KMT UHP pneumatic valves.

20475871



ACTUATORS

HP Actuator - N/O, 60,000 psi

10189553

HP Actuator - N/C, 60,000 psi

10177855

UHP Actuator – N/O, 90,000 psi

20479022

UHP Actuator – N/C, 90,000 psi

20474154



PNEUMATIC VALVE PARTS

NOZZLE TUBES

ABRASIVE MANAGEMENT SYSTEMS

DESCRIPTION

PART No.

BACKUP RINGS

HP Pneumatic Valve, Stainless Steel, 60,000 psi.

For use on all KMT HP pneumatic valves.

10187250

UHP Pneumatic Valve, Stainless steel, 90,000 psi

For use on all KMT UHP pneumatic valves.

20475882



NOZZLE NUTS

.38, LH Thread , 60,000 psi

B2841

.56, LH Thread , 60,000 psi

B3393



VALVE GLANDS

.56, Valve nut for Nozzle Tube, Stainless Steel,
60,000 psi/90,000 psi

BV701184

.75 Valve nut for Nozzle Tube, Stainless Steel,
60,000 psi/90,000 psi

20454351

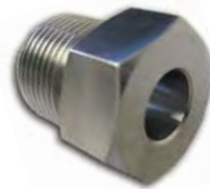

Compression Spring - .72 x .105 x 1.50, Stainless Steel

For use on all NC KMT HP/UHP pneumatic actuators.

05054119



DESCRIPTION

PART No.

<p>HP Collar - .38, Stainless Steel. 66,000 psi</p>	<p>10078715</p>	
<p>Adapter, HP Water Valve. For use on all 60,000 psi 3-port and quick release dump valves.</p>	<p>49830904</p>	
<p>Adapter, Tube/Pipe, .25 x .13 Used to connect air hose to solenoid valve on pneumatic valve/actuator assemblies.</p>	<p>10077030</p>	
<p>Coupling Pipe, .13 x .13 Used to connect solenoid valve to actuator on pneumatic valve/actuator assemblies.</p>	<p>10102226</p>	
<p>HP Bushing Assembly, .56 M x .25 F, Stainless Steel. 66,000 psi</p>	<p>10079580</p>	
<p>HP Gland - Anti-Vibration, .38, Stainless Steel. 66,000 psi</p>	<p>10078913</p>	

PNEUMATIC VALVE PARTS

NOZZLE TUBES

ABRASIVE MANAGEMENT SYSTEMS

DESCRIPTION

PART No.

NOZZLE TUBES

(All Dimensions are Diameter" x Length")

3/8" Connection, 60,000 psi

.38 x 4.0	10138584
.38 x 5.0	10138592
.38 x 6.0	10138600
.38 x 7.0	10138618
.38 x 8.0	10138634
.38 x 9.0	10138642
.38 x 10.0	10138659

MEASUREMENT CALCULATOR:

.25 = 1/4 inch | .56 = 9/16 inch
 .38 = 3/8 inch | .75 = 3/4 inch



3/8" Nozzle Nut Connection, 60,000 psi

.38 x 4.0	10138402
.38 x 5.0	10138410
.38 x 6.0	10138428
.38 x 7.0	10138436
.38 x 8.0	10138444
.38 x 9.0	10138451
.38 x 10.0	10138469
.38 x 11.0	05136031
.38 x 12.0	05013735



3/8" Nozzle Nut Connection W/High Pressure Connection, 60,000 psi

.38 x 3.0	A22593
.38 x 4.0	A22594
.38 x 5.0	A22595
.38 x 6.0	A22596
.38 x 8.0	A2259800
.38 x 10.0	A225910
.38 x 11.0	A225911
.38 x 12.0	A225912



DESCRIPTION

PART No.

NOZZLE TUBES

(All Dimensions are Diameter" x Length")

9/16" Connection, 60,000 psi

.56 x 4.0	10138667
.56 x 5.0	10138675
.56 x 6.0	10138683
.56 x 7.0	10138691
.56 x 8.0	10138709
.56 x 9.0	10138717
.56 x 10.0	10138725
.56 x 11.0	80074446

MEASUREMENT CALCULATOR:

.25 = 1/4 inch | .56 = 9/16 inch
 .38 = 3/8 inch | .75 = 3/4 inch



9/16" Nozzle Nut Connection, 60,000 psi

.56 x 4.0	10138485
.56 x 5.0	10138493
.56 x 6.0	10138501
.56 x 7.0	10138519
.56 x 8.0	10138527
.56 x 9.0	10138535
.56 x 10.0	10181105
.56 x 12.0	10193100



3/4" For use with KMT IDE® Cutting Head, 60,000 psi

.75 x 3.75, LH Thread	20489074
.75 x 4.75, LH Thread	20489092
.75 x 5.75, LH Thread	20455329
.75 x 7.75, LH Thread	20480977
.75 x 8.75, LH Thread	72101354
.75 x 9.75, LH Thread	20464647



NOZZLE TUBES

ABRASIVE MANAGEMENT SYSTEMS

FITTINGS & TUBING

DESCRIPTION

PART No.

NOZZLE TUBES

(All Dimensions are Diameter" x Length")

3/4" Ultra High Pressure Nozzle Tube, for use with Short Stop Filter, 90,000 psi

.75 x 3.50, LH Thread	20487241
.75 x 4.50, LH Thread	20487249
.75 x 5.75, LH Thread	20487257
.75 x 6.25, LH Thread	20497106
.75 x 9.75, LH Thread	20487273

MEASUREMENT CALCULATOR:

.25 = 1/4 inch | .56 = 9/16 inch
 .38 = 3/8 inch | .75 = 3/4 inch





MEASUREMENT CALCULATOR:

.25 = 1/4 inch | .56 = 9/16 inch
.38 = 3/8 inch | .75 = 3/4 inch

ABRASIVE MANAGEMENT SYSTEMS

The garnet used in cutting hard materials represents one of the biggest operating expenses of a waterjet system, so the abrasive management system you use needs to be accurate and dependable.

KMT offers abrasive management systems at various performance levels, each manufactured to the high precision and reliability standards you've come to expect from KMT.



KMT Genuine Parts
Your business is worth it.

DESCRIPTION

PART NO.

ABRASIVE METERING SYSTEMS

An accurate & consistent abrasive feed-rate is critical to the waterjet abrasive cutting process. A well regulated feed rate of abrasive cuts down on waste, saves money and results in a tighter cutting stream with a cleaner, smoother cutting edge.

E-Z Feedline®

KMT Waterjet Systems introduces EZ Feedline® Abrasive Metering System, an economical, reliable and EZ option for accurate delivery of abrasive to the cutting nozzle. The KMT EZ Feedline® is EZ to mount, operate and maintain---no tools required to replace wear components!

20486762



Feedline Precision®

The KMT Feedline Precision® with the innovative Dial-It-In variable control provides abrasive feed rate precision and flexibility. The full spectrum dial, notched in 1/10 lb. increments, delivers precise flow control of abrasive from 0 to 2-1/2 lbs./min. for economical and custom cutting of a variety of materials and thicknesses.

20497504



Feedline V®

The KMT Feedline V® abrasive metering system is precisely and accurately controlled through a central CNC controller or a potentiometer, and supplies the cutting head with the optimized flow of abrasive---this helps save material and costs. The gravity fed abrasive automatically feeds to the fill line & there's no need to pause the cutting process. With a quick turn of a knob, the abrasive feed rate can be adjusted to increase or decrease the abrasive stream.

72105096



Polyurethane Tubing - .38, Clear

49885361



PVC Tubing - .50 x .748, Reinforced, Static-free

05076963



MEASUREMENT CALCULATOR:

.25 = 1/4 inch | .56 = 9/16 inch
.38 = 3/8 inch | .75 = 3/4 inch



HIGH PRESSURE FITTINGS & TUBING

KMT offers high pressure tubing and fittings for all waterjet system needs and other high-pressure applications. Engineered for long life and reliability, KMT fittings are rated for use at 60,000psi and 100,000psi.

KMT employs proprietary manufacturing processes to ensure the longest life for HP and UHP tubing. Customized design is available to meet your needs – contact KMT Customer Service for details.

KMT Genuine Parts
Your business is worth it.

DESCRIPTION

PART No.

DESCRIPTION

PART No.



HP Stainless Steel Coupling Assembly, 60,000 psi

.25 x .25	10079028
.38 x .25	10079614
.38 x .38	10078905
.56 x .25	10078145
.56 x .38	10079531
.56 x .56	10078640



UHP Stainless Steel Coupling Assembly, 100,000 psi

.25 x .25	20477023
.38 x .25	20477738
.38 x .38	20477660
.56 x .25	20477730
.56 x .38	20477709
.56 x .56	20477685



HP Stainless Steel Elbow Assembly, 60,000 psi

.25	10079051
.38	10078780
	10078525



UHP Stainless Steel Elbow Assembly, 100,000 psi

.25	20455821
.38	20455809
.56	20455377

MEASUREMENT CALCULATOR:

.25 = 1/4 inch | .56 = 9/16 inch
 .38 = 3/8 inch | .75 = 3/4 inch

HP & UHP FITTINGS

TUBING

SWIVEL JOINT ASSY'S.

DESCRIPTION

PART No.

DESCRIPTION

PART No.



HP Stainless Steel Tee Assembly, 60,000 psi

.25	10079481
.38	10078590
.56	10079465



UHP Stainless Steel Tee Assembly, 100,000 psi

.25	20455824
.38	20455812
.56	20455374



HP Stainless Steel Cross Assembly, 60,000 psi

.25	10097228
.38	10078038
.56	10079168



UHP Stainless Steel Cross Assembly, 100,000 psi

.25	20452971
.38	20452968
.56	20453115

MEASUREMENT CALCULATOR:

.25 = 1/4 inch | .56 = 9/16 inch
 .38 = 3/8 inch | .75 = 3/4 inch

HP & UHP FITTINGS

TUBING

SWIVEL JOINT ASSY'S.

DESCRIPTION

PART No.

DESCRIPTION

PART No.



HP Stainless Steel Bushing Assembly, 60,000 psi

.38 M x .25 F	10079432
.38 F x .25 M	10079473
.56 M x .25 F	10079580
.56 F x .25 M	10079424
.56 M x .38 F	10079457
.56 F x .38 M	10079655

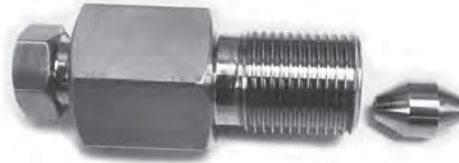

UHP Stainless Steel Bushing Assembly, 100,000 psi

.38 F x .25 M	72133175
.38 M x .25 F	72133224
.56 F x .25 M	72133183
.56 M x .25 F	72133232
.56 F x .38 M	72133209
.56 M x .38 F	72133250



HP Stainless Steel Collar 60,000 psi

.25	10078426
.38	10078715
.56	10079119

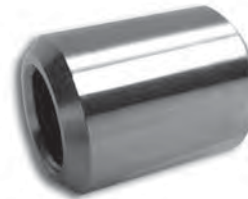

UHP Stainless Steel Collar 100,000 psi

.25	20452959
.38	20452965
.56	20453124

MEASUREMENT CALCULATOR:

.25 = 1/4 inch | .56 = 9/16 inch
 .38 = 3/8 inch | .75 = 3/4 inch

HP & UHP FITTINGS

TUBING

SWIVEL JOINT ASSY'S.

DESCRIPTION

PART No.

DESCRIPTION

PART No.



**HP Stainless Steel Gland
60,000 psi**

.25	10078459
Anti-Vibration, .25	10078699
.38	10078129
Anti-Vibration, .38	10078913
.56	10078608
Anti-Vibration, .56	10093573



**UHP Stainless Steel Gland
100,000 psi**

.25	20452962
.38	20452956
.56	20453121



**HP Stainless Steel Adapter
Cone, 60,000 psi**

.25	10116333
.38	10078509
.56	10079291



**UHP Stainless Steel Adapter
Cone, 100,000 psi**

.25	72133266
.38	72122072
.56	72133349

MEASUREMENT CALCULATOR:
 .25 = 1/4 inch | .56 = 9/16 inch
 .38 = 3/8 inch | .75 = 3/4 inch

HP & UHP FITTINGS

TUBING

SWIVEL JOINT ASSY'S.

DESCRIPTION

PART No.

DESCRIPTION

PART No.



**HP Stainless Steel Plug
60,000 psi**

.25

10078244

.38

10079523

.56

10078772



**UHP Stainless Steel Plug
100,000 psi**

.25

20453130

.38

20453136

.56

20453127



**HP Stainless Steel Hand
Valve, Straight, 60,000 psi**

.25

10079259

.38

10078863

.56

10078889



**UHP Stainless Steel Hand
Valve, Straight, 100,000 psi**

.25

20467981

.38

20468568

.56

20468014

MEASUREMENT CALCULATOR:

.25 = 1/4 inch | .56 = 9/16 inch
.38 = 3/8 inch | .75 = 3/4 inch

HP & UHP FITTINGS

TUBING

SWIVEL JOINT ASSY'S.

DESCRIPTION

PART No.

DESCRIPTION

PART No.



HP Stainless Steel Hand Valve, 90 degree, 60,000 psi

.25

10079002

.38

10078749

.56

10079275



UHP Stainless Steel Hand Valve, 90 degree, 100,000 psi

.25

20468610

.38

20468593

.56

20477836



HP Stainless Steel Valve Assembly, 3-Way, 1 Press, .38, 2 Stem 60,000 psi

10119030



Hand Valve

10097533

MEASUREMENT CALCULATOR:

.25 = 1/4 inch | .56 = 9/16 inch
.38 = 3/8 inch | .75 = 3/4 inch

HP & UHP FITTINGS

TUBING

SWIVEL JOINT ASSY'S.

DESCRIPTION

PART NO.

STAINLESS STEEL TUBING - 66,000 PSI

CONED & THREADED - UP TO 8.0" LENGTHS

.25 x .083 x 4.0", 316

10105880

.25 x .083 x 6.0", 316

10103018

.25 x .083 x 8.0", 316

80070519

.38 x .125 x 3.0", 316

10094704

.38 x .125 x 4.0", 316

10105443

.38 x .125 x 5.0", 316

10090280

.56 x .188 x 4.0", 316

10069326

.56 x .188 x 4.97", 316

05112057



CONED & THREADED - 20' LENGTH

.25 x .083 x 240.0", 316

10094191

.38 x .125 x 240.0", 316

10094183

.56 x .188 x 240.0", 316

10094175



MEASUREMENT CALCULATOR:

.25 = 1/4 inch | .56 = 9/16 inch
 .38 = 3/8 inch | .75 = 3/4 inch

DESCRIPTION

PART No.

STAINLESS STEEL TUBING - 100,000 PSI

CONED & THREADED - UP TO 4' LENGTHS

.25 x .083 x 3.02", HP160	20489761
.25 x .083 x 4.0", HP160	20487975
.25 x .083 x 7.625", HP160	72104402
.38 x .125 x 4.0", HP160	20478649
.38 x .125 x 4.81", HP160	20468830
.38 x .125 x 48.0", HP160	20489107
.56 x .188 x 4.25", HP160	20493999
.56 x .188 x 6.38", HP160	72103733
.56 x .188 x 8.93", HP160	72103386
.56 x .188 x 14.49", HP160	72103361
.56 x .188 x 17.22", HP160	72103379
.56 x .188 x 36.0", HP160	72108319

MEASUREMENT CALCULATOR:

.25 = 1/4 inch | .56 = 9/16 inch
 .38 = 3/8 inch | .75 = 3/4 inch



CONED & THREADED - 20' LENGTH

.25 x .083 x 240.0", HP160	20478751
.38 x .125 x 240.0", HP160	20489115
.56 x .188 x 240.0", HP160	72103535



TUBING

SWIVEL JOINT ASSY'S.

INLINE WATER FILTERS

DESCRIPTION

PART No.

Hose – Ferrule, .25 x .265 x .718, Brass

20422970

Hose – Ferrule, .38 x .265 x .718, Brass

10083897

Hose – Ferrule, .56 x .265 x .718, Brass

05131347



Conduit - Extra Flexible - .25, Stainless steel

20422988

Conduit - Extra Flexible - .38, Stainless steel

10186153

Conduit - Extra Flexible - .56, Stainless steel

05086905



HP & UHP STAINLESS STEEL BENT TUBING IS INTENSIFIER MODEL SPECIFIC. PLEASE CONTACT KMT GENUINE PARTS CUSTOMER SERVICE FOR ORDERING ASSISTANCE @800-991-4225.

HP & UHP STAINLESS STEEL COILS ARE ROBOT SPECIFIC. PLEASE CONTACT KMT CUSTOMER SERVICE FOR ORDERING ASSISTANCE @800-991-4225.

HP & UHP STAINLESS STEEL STRAIGHT TUBING IS SOLD IN RANDOM LENGTHS. PLEASE CONTACT KMT CUSTOMER SERVICE FOR ORDERING ASSISTANCE @800-991-4225.



REPAIR & TOOL KITS

Repair Kit - HP Swivel Joint Assembly, .25/.38
Connections, 60,000 psi

Kit includes seal assembly, thrust bearing and washer, and setscrew required to service all HP swivel joint assemblies.

05116009



Repair Kit -UHP Swivel Joint Assembly, .25/.38
Connections, 90,000 psi

Kit includes seal assembly, thrust bearing and washer, and setscrew required to service all UHP swivel joint assemblies.

72129713



Tool Kit - UHP Swivel Joint Assembly, 90,000 psi
Kit includes maintenance tools and lubricants required to repair any UHP swivel joint assembly.

20488720



MEASUREMENT CALCULATOR:

.25 = 1/4 inch | .56 = 9/16 inch
.38 = 3/8 inch | .75 = 3/4 inch

DESCRIPTION

PART No.

SPINDLES

HP Spindle - .25 F, 60,000 psi

CJ318088

HP Spindle - .25 M, 60,000 psi

CJ501288

HP Spindle - .38 M, 60,000 psi

49899602

UHP Spindle - .25 F, 90,000 psi

20486952

UHP Spindle - .25 M, 90,000 psi

20490843



STRAIGHTS

HP, Straight, .25 M/F Connections, 60,000 psi

CJ211388

HP, Straight, .25 F/F Connections, 60,000 psi

CJ218088

HP, Straight, .38 M/F Connections, 60,000 psi

10134708

UHP, Straight, .25 F/F Connections, 90,000 psi

20477623

UHP, Straight, .25 F/M Connections, 90,000 psi

20490851



DESCRIPTION

PART No.

CONNECTIONS

HP, 90°, .25 F/F Connections, 60,000 psi

CJ218188

HP, 90°, .25 M/F Connections , 60,000 psi

CJ201288

HP, 90°, .38 M/F Connections, 60,000 psi

10134682

UHP, 90°, .25 F/F Connections, 90,000 psi

20491098



CAP ASSEMBLIES

Cap Assembly, 60,000 psi, .25/.38, M/F

BJ701288

Cap Assembly, 60,000 psi, .25, F/F

CJ418088



STRAIGHT BODIES

HP Body - Straight, 60,000 psi, .25 Connections

CJ311388

HP Body - Straight, 60,000 psi, .38 Connections

10134716

UHP Body - Straight, 90,000 psi, .25 Connections

20486976



SWIVEL JOINT ASSY'S.

INLINE WATER FILTERS

TOPWORKS

DESCRIPTION	PART NO.	
<p>90 DEGREE BODIES</p> <p>HP Body – 90°, 60,000 psi, .56 x .25 M/F Connections</p> <p>HP Body - 90°, 60,000 psi, .38 x .38 M/F Connections</p> <p>UHP Body - 90°, 90,000 psi, .25 Connections</p>	<p>DJ301288</p> <p>10134690</p> <p>20490859</p>	
<p>BUSHINGS</p> <p>Bushing – 60,000 psi, .25/.38 Connection</p>	<p>CJ401288</p>	
<p>THRUST BEARINGS</p> <p>Thrust Bearing – 60,000 psi, .25/.38 Connection</p> <p>Thrust Bearing - 90,000 psi, .25 Connections</p>	<p>10084713</p> <p>20475956</p>	
<p>SEAL ASSEMBLIES</p> <p>Seal Assembly – 60,000 psi, .25/.38 Connection</p> <p>Seal Assembly - 90,000 psi, .25 Connections</p>	<p>BJ201388</p> <p>20487002</p>	
<p>Clamp Collar - 60,000 psi, .25, F/F Connection</p>	<p>10154680</p>	
<p>Thrust Washer – 60,000 psi, .25/.38 Connections</p>	<p>10094647</p>	

DESCRIPTION

PART No.

INLINE WATER FILTERS

Filter Element - HP Water Filter Assembly, 60,000 psi
 .25, Sintered Cup, 20 Micron.
 For use with HP Filter Assembly 05114137

05110531

Filter Element - HP Water Filter Assembly, 60,000 psi
 .38, Sintered Cup, 20 Micron.
 For use with HP Filter Assembly CJ200988

SKJA266

Filter Element - HP Water Filter Assembly, 60,000 psi
 .56, Sintered Cup, 20 Micron.
 For use with HP Filter Assembly BF103473

AF503473

Filter Element - UHP Water Filter Assembly, 90,000 psi
 Sintered Cup, 20 Micron.
 For use with UHP Filter Assembly 20475916 & 20475944

20453553

Filter Element - UHP Water Filter Assembly, 90,000 psi
 Sintered Cup, 20 Micron.
 For use with UHP Filter Assembly 20481026 & 20480940

20456913

WATER FILTER ASSEMBLIES

HP Water Filter Assembly - Inline, 60,000 psi
 .25, 20 Micron, Stainless Steel

05114137

HP Water Filter Assembly - Inline, 60,000 psi
 .38, 20 Micron, Stainless Steel

CJ200988

HP Water Filter Assembly - Inline, 60,000 psi
 .56, 20 Micron, Stainless Steel

BF103473

MEASUREMENT CALCULATOR:

.25 = 1/4 inch | .56 = 9/16 inch
 .38 = 3/8 inch | .75 = 3/4 inch



DESCRIPTION

PART No.

WATER FILTER ASSEMBLIES

MEASUREMENT CALCULATOR:
 .25 = 1/4 inch | .56 = 9/16 inch
 .38 = 3/8 inch | .75 = 3/4 inch

UHP Water Filter Assembly - Inline, 90,000 psi
 .25, Stainless Steel

20481026



UHP Water Filter Assembly - Inline, 90,000 psi
 .38, Stainless Steel

20480940

UHP Water Filter Assembly - Inline, 90,000 psi
 .38, Stainless Steel

20475916



UHP Water Filter Assembly - Inline, 90,000 psi
 .56, Stainless Steel

20475944

Bayonet Nipple - HP Water Filter, 60,000 psi, .38
 For use in HP Filter Assembly CJ200988

SKJA287





TOPWORKS REPLACEMENT PARTS



KMT Genuine Parts
Your business is worth it.

**NO OTHER SYSTEM INCORPORATES THE FEATURES OF
KMT INTENSIFIERS TO DELIVER THE SIMPLEST, EASIEST-TO-OPERATE,
MOST RELIABLE SYSTEM.**



The KMT intensifier is the heart of your waterjet system and helps determine the quality and quantity of the products you make. The use of KMT Genuine Parts to maintain your intensifier helps maximize life and improves value.

KMT PRO® replacement parts are available exclusively from KMT and require precision manufacturing to ensure the best performance from your PRO® pump.

The KMT Intensifier Features:

- **Plunger** – KMT intensifiers use a longer pressurizing stroke than other manufacturers, thereby stroking less frequently for longer life.
- **Seals** – KMT's Hyperlife™ seals (U.S. Patent #6,769,695 and Sweden Patent #0203660-6) used in the Streamline topworks provides greater value than inferior, imitation parts.
- **Metal-to-Metal Seal Head** – Ensures positive sealing and the ability to re-use crucial components.

REPAIR KITS

Repair Kit - Hydraulic Piston, .88 plunger units.
 55,000/60,000 psi. Used on all SL-V, E-Series and S-Series units with a 15 to 60 horsepower rating. Kit includes retaining rings, bearings, o-rings, backup rings, seal assembly and check valves.

05115951



Repair Kit - HP Cylinder Assembly

Used on SL-III, 55,000 psi. Kit includes seals, o-rings and backup rings to repair the HP cylinder seal and the sealing head seal.

05115969



Repair Kit - HP Cylinder Assembly

Used on SL-IV, 55,000 psi. Kit includes seals, o-rings and backup rings to repair the HP cylinder seal and the sealing head seal.

05115977



Repair Kit - HP Cylinder Assembly

Used on SL-I/SL-II, 55,000 psi. Kit includes seals, o-rings and backup rings to repair the HP cylinder seal and the sealing head seal.

05115993



DESCRIPTION

PART No.

SEAL ASSEMBLIES

HP Seal Assembly - .88 plunger units. 55,000 psi
Used on all SL-IV units.

05123385



HP Seal Assembly - .88 plunger units. 55,000/60,000 psi
Used on all SL-V, E-Series and S-Series units with a 15 to 60 horsepower rating.

20422243



HP Seal Assembly - .88 plunger units. 55,000/60,000 psi
Used on SL-IV Plus flange units & SL-V HSEC units.

05149703



HP Seal Assembly - 1.13 plunger units, hybrid

20467135



HP Seal Assembly - 1.13 plunger units. 60,000 psi
Used on all SL-V units with a 75 to 200 horsepower rating.

05149711



UHP Seal Assembly - .88 plunger units. 90,000 psi
Used on all PRO units with a 60 or 125 horsepower rating.

20479499



DESCRIPTION

PART NO.

CYLINDER SEAL ASSEMBLIES

HP Cylinder Seal Assembly - 55,000 psi
Used on SL-III & SL-IV units.

05027172



HP Cylinder Seal Assembly - 55,000 psi
Used on SL-I & SL-II units.

10144590



PROXIMITY SWITCH KITS

Proximity Switch Kit - E50. 55,000 - 60,000 psi
Used on all SL-III, SL-IV, SL-V, E-Series and S-Series units with a 15 to 60 horsepower rating.

Replaces Part #05127584

20453934



Proximity Switch Kit - Used on 60,000 psi/75-200 horsepower 1-1/8" plunger intensifiers.

Used on all 90,000 psi PRO units.

20453925



TOPWORKS PARTS

SEALING HEADS

MISCELLANEOUS PARTS

DESCRIPTION

PART NO.

HYDRAULIC CYLINDERS & HEADS

Hydraulic Cylinder, .88 plunger HSEC units, 55,000/60,000 psi
Used on all SL-IV, SL-V, E-Series and S-Series units with a 15 to 60 horsepower rating.

05034764



Hydraulic Cylinder, 1.13 plunger HSEC units, 55,000/60,000 psi
Used on all SL-V units with a 75 to 200 horsepower rating.

05144514

Hydraulic Cylinder Head, 55,000 psi
.88 plunger, HSEC units. Used on all E-Series units with a 30 or 50 horsepower rating.

20414880



Hydraulic Cylinder Head, 60,000 psi
.88 plunger, HSEC units. Used on all SL-IV, SL-V and S-Series units with a 15 to 60 horsepower rating.

05034772



Hydraulic Cylinder Head, 60,000 psi
1.13 plunger, HSEC units. Used on all SL-V units with a 75 to 200 horsepower rating.

20416445



DESCRIPTION

PART No.

PUMP PLUNGERS

Carbide Plunger, .88 plunger units, 55,000 psi
Used on all E-Series units with a 30 or 50 horsepower rating. Used on all SL-I & SL-II intensifiers.

05039771



Ceramic Plunger - .88 plunger units, 60,000/90,000 psi
Used on all SL-V and S-Series units with a 15 to 60 horsepower rating and PRO units with a horsepower rating of 60 or 125.

05119151



Ceramic Plunger - 1.13 plunger units, 60,000 psi
Used on all SL-V units with a 75 to 200 Horsepower rating.

05144506



LINERS

Liner – HP Cylinder .88 plunger units, 60,000 psi

20497767



Liner - HP Cylinder, .88 plunger units, Brass, 60,000 psi

20491603

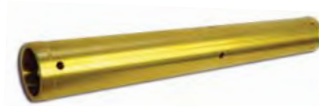

Liner - HP Cylinder, 1.13 plunger units, 60,000 psi
Used on all SL-V units with a 75 to 200 horsepower rating.

72110945



Replaces Part #05144555

Liner - UHP Cylinder, .88 plunger units, 90,000 psi
Used on all PRO units with a 60 or 125 horsepower rating.

20474333



DESCRIPTION

PART NO.

BACKUP RINGS

3.75 x 4.0, .88 plunger units, 55,000/60,000 psi
Used on all SL-IV, SL-V, E-Series and S-Series units with a 15 to 60 horsepower rating.

05034855

5.25 x 5.50, 1.13 plunger units, 60,000 psi

Used on all SL-V units with a 75 to 200 horsepower rating.

05120092

Hydraulic Piston Assembly, 15 to 60 horsepower

Used on SL-IV, SL-V & S-Series 7/8" plunger units.

Used on all 90,000 psi PRO units.

05049994

**HYDRAULIC CARTRIDGE SEAL ASSEMBLIES**

.88 plunger units, 60,000/90,000 psi

Used on all SL-IV, SL-V and S-Series units with a 15 to 60 horsepower rating and all PRO units with a 60 or 125 Horsepower rating.

05130091

1.13 plunger units, 60,000 psi

Used on all SL-V units with a 75 to 200 horsepower rating.

05146584

.88 plunger units, 55,000 psi

Used on all E-Series units with a 30 or 50 horsepower rating & NEOLine 40i units.

80086622

**HYDRAULIC PISTON ASSEMBLIES**

.88 plunger units. 55,000/60,000 psi. Used on all SL-IV, SL-V, E-Series and S-Series units with a 15 to 60 horsepower rating.

Kit includes piston, retaining rings, bearings, o-rings, backup rings, seal assembly and check valves.

05132253

1.13 plunger units. 55,000/60,000 psi. Used on all SL-V units with a 75 to 200 horsepower rating.

Kit includes piston, retaining rings, bearings, o-rings, backup rings, seal assembly and check valves.

05146576



DESCRIPTION

PART No.

<p>Seal Assembly - Hydraulic Piston, .88 plunger units. 55,000/60,000 psi. Used on all SL-V, E-Series and S-Series units with a 15 to 60 horsepower rating.</p>	<p>05117965</p>	
<p>Packing Ring - Hydraulic Cartridge Seal Assembly. 55,000 psi. Used on SL-III units.</p>	<p>05015060</p>	
<p>Bearing - Hydraulic Piston, .88 plunger units, 55,000/60,000 psi. Used on all SL-V, E-Series and S-Series units with a 15 to 60 horsepower rating.</p>	<p>05117940</p>	
<h2>CYLINDERS</h2>		
<p>.88 plunger HSEC units. 52,000 psi Used on all E-Series version I units with a 50 horsepower rating. Replaces Part #20414862</p>	<p>72120023</p>	
<p>.88 plunger HSEC units. 55,000 psi Used on all E-Series units with a 30 or 50 horsepower rating. Replaces Part #20434777</p>	<p>72119529</p>	
<p>.88 plunger. 55,000 psi Used on SL-IV units.</p>	<p>05059712</p>	
<p>.88 plunger. 55,000 psi Used on SL-I & SL-II units. Replaces Part #10097822</p>	<p>05136312</p>	

TOPWORKS PARTS

SEALING HEADS

MISCELLANEOUS PARTS

DESCRIPTION

PART No.

CYLINDERS

Cylinder - .88 plunger HSEC. 60,000 psi
Used on all SL-V and S-Series units with a 15 to 60 horsepower rating.

Replaces Part #20479503 & #05144647

72119544



Cylinder - 1.13 plunger HSEC units. 60,000 psi
Used on all SL-V units with a 75 to 200 horsepower rating.

Replaces Part #20473479 & #20431076

72119536

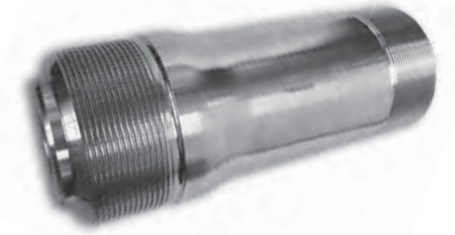

PRO Cylinder - .88 plunger units. 90,000 psi
Used on all PRO® units with a 60 or 125 horsepower rating.

Replaces Part #20453688

72121850



PRO² Cylinder - .88 plunger units. 90,000 psi
Used on all PRO²® units with a 60 or 125 horsepower rating.

72121858

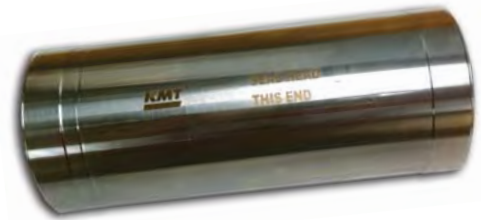

HP Cylinder Head - 55,000 psi.
Used on SL-I and SL-II units.

10097855



DESCRIPTION

PART No.

HP Cylinder Assembly - .88 plunger. 55,000 psi
Used on SL-I & SL-II units.

10098366

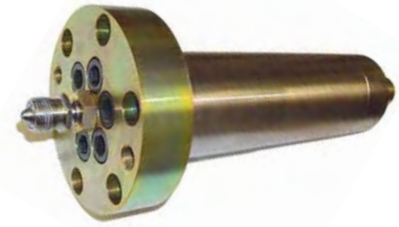

HIGH PRESSURE CYLINDER NUTS

HP Cylinder Nut – SSEC (Soft Seal End Cap).

Used on SL-IV. 55,000 psi

05059688

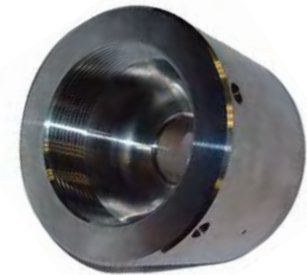

HP Cylinder Nut - HSEC (Hard Seal End Cap), .88 plunger.

60,000 psi. Used on all SL-V and S-Series units with a 15 to 60 horsepower rating.

80073646

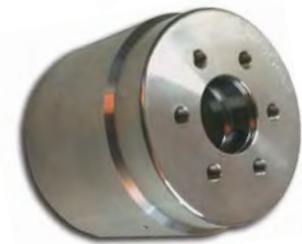

Packing Follower - HP Cylinder Assembly, 1.373 x .878.

55,000 psi. Used on SL-I & SL-II units.

AP1412671



TOPWORKS PARTS

SEALING HEADS

MISCELLANEOUS PARTS

DESCRIPTION

PART NO.

BUSHING RETAINER FLANGES

.88 plunger units, 55,000/60,000 psi

Used on all SL-IV, SL-V, E-Series & S-Series units with a 15 to 60 horsepower rating.

05007786



1.13 plunger units, 60,000 psi

Used on all SL-V units with a 75 to 200 horsepower rating.

05145099

**RETAINING RINGS**

2.75, Stainless steel.

Used on all 60,000 psi units

05034798



1.011 x .030 x .118, Stainless Steel, 90,000 psi

Used on all 90,000 psi units.

20492123



Jackbolt - HSEC, 7/16-20 x 2.31. Used on all SL-V, E-Series and S-Series HSEC units.

80070352



HP Attenuator Assembly - .96L

Used on all 60,000 psi units.

20498314





SEALING HEADS

KMT's patent-pending sealing head design offers reliable, repeatable use. The metal-on-metal seal ensures that your KMT intensifier reaches operating pressure safely, providing hundreds of hours of operation to support your cutting needs.

The use of KMT Genuine Parts to rebuild your sealing head results in maximum value and safe operation.

KMT Genuine Parts
Your business is worth it.

DESCRIPTION

PART NO.

REPAIR KITS

HP Check Valve, .88 plunger units.

Used on SL-I & SL-II units, 55,000 psi. Kit includes seal, ball seat, compression spring, ball & ball retainer.

05115985

**HP Check Valve Discharge, .88 plunger units.**

55,000/60,000 psi. Used on all SL-V, E-Series and S-Series units with a 15 to 60 horsepower rating. Kit includes valve seat, discharge poppet, poppet pin and compression spring.

05133335

**HP Check Valve, Inlet/Discharge, .88 plunger units.**

55,000/60,000 psi
Used on all SL-V, E-Series and S-Series units with a button style poppet with a 15 to 60 horsepower rating. Kit includes valve seat, inlet and discharge poppets, poppet pin, compression spring & poppet retainer screw.

20489495

**HP Check Valve, Inlet/Discharge, .88 plunger units.**

55,000/60,000 psi. Used on SL-III, SL-IV & SL-V units with a washer style inlet poppet. Kit includes valve seat, inlet & discharge poppets, poppet pin & compression springs.

80074057

**HP Check Valve, Inlet/Discharge, 1.13 plunger units.**

60,000 psi. Used on all SL-V units with washer style inlet with a 75 to 200 horsepower rating. Kit includes valve seat, inlet and discharge poppets, poppet pin and compression spring.

20427747

**HP Check Valve, Inlet/Discharge, 1.13 plunger units.**

60,000 psi. Used on all SL-V units with a button style poppet with a 75 to 200 horsepower rating. Kit includes valve seat, inlet and discharge poppets, poppet pin and compression spring.

72125203

**HP Check Valve, Discharge, 1.13 plunger units.**

60,000 psi. Used on all sealing head assemblies for SL-V units with a 75 to 200 horsepower rating. Kit includes valve seat, discharge poppet, poppet pin and compression spring.

80084403



DESCRIPTION

PART No.

REPAIR KITS

UHP Check Valve (Poppet Style) Inlet
Inlet/discharge, .88 plunger units, 90,000 psi. Used on all sealing head assemblies for SL PRO® units that utilize an inlet poppet. Kit includes valve seat, inlet and discharge poppets, poppet pin and compression spring.

20477505



UHP Check Valve (Ball Style) Inlet
Inlet/discharge, .88 plunger units, 90,000 psi. Used on all sealing head assemblies for PRO® units only (*not PRO2®*) that utilize an inlet ball. Kit includes valve seat, discharge poppet, inlet ball, poppet pin & compression spring.

72110531



UHP Check Valve PRO2® (Inlet/Discharge) Ball Style
Inlet/discharge, .88 plunger units, 90,000 psi. Used on all SL PRO2® units that utilize an inlet ball. Kit includes seat, discharge poppet, inlet ball, poppet pin, dowel pin & compression spring.

72117819



UHP Check Valve PRO2® (Discharge) Discharge Kit, .88 plunger units, 90,000 psi. Used on sealing head assemblies for SL PRO2® units. Kit includes seat, discharge poppet, poppet pin & compression spring.

72135447



SEAL ASSEMBLIES

HP Sealing Head 55,000 psi. Used on SL-III & SL-IV units

10110393

HP Sealing Head 55,000 psi. Used on SL-I & SL-II units.

10178614



Check Valve - LP/HP pump. Used on SL-I & SL-II units.

BV118874



HP Check Valve – Body. 55,000 psi. Used on SL-I & SL-II units.

BV610174



DESCRIPTION

PART No.

SEALING HEAD ASSEMBLIES

.88 plunger units, 55,000 psi. Used on SL-III and SL-IV units.

Use KMT Repair Kit 80074057 (see pg. 68)

05116769



.88 plunger units, 55,000/60,000 psi. Used on all SL-V, E-Series and S-Series units with a 15 to 60 horsepower rating.

Use KMT Repair Kit 20489495 (see pg. 68)

20481005



.88 plunger units, 60,000 psi. Used on SL-IV Plus flange units.

Use KMT Repair Kit 80074057 (see pg. 68)

05144688



1.13 plunger units, 60,000 psi. Used on all SL-V units with a 75 to 200 horsepower rating.

Use KMT Repair Kit 72125203 (see pg. 68)

72110979



.88 plunger, 4 stud.

Used on all PRO® units (*Not PRO²® units*).

Use KMT Repair Kit 72110531 (see pg. 69)

20480113



.88 plunger.

Used on all PRO²® units.

Use KMT Repair Kit 72117819 (see pg. 69)

20480087



SEALING HEADS

.88 plunger, 55,000 psi
Used on SL-I & SL-II units.

10097871



.88 plunger units. 55,000/60,000 psi
Used on all sealing head assemblies for SL-V, E-Series and S-Series units with a 15 to 60 horsepower rating.

20481009



.88 plunger units. 60,000 psi
Used on SL-IV Plus flange units.

05144357



.88 plunger units. 55,000 psi
Used on SL-III & SL-IV units with a 15 to 60 horsepower rating.

10106417



1.13 plunger units. 60,000 psi
Used on all sealing head assemblies for SL-V units with a 75 to 200 horsepower rating.

72110961



.88 plunger units. 90,000 psi
Used on all sealing head assemblies for PRO® units only
(Not PRO²® units).

20479524



DESCRIPTION

PART NO.

GLANDS

HP Check Valve Gland Nut, .88 plunger units.
55,000 psi. Intermediate Gland used on SL-I & SL-II units.

AV317274



HP Check Valve Gland Nut, Ball style, .88 plunger units. 55,000 psi. Used on SL-III units.

10107910



HP Check Valve Gland Nut, 1.13 plunger units. 60,000 psi. Used on all sealing head assemblies for SL-V units with a 75 to 200 horsepower rating.

05116595



HP Check Valve Gland Nut, .88 plunger units.
55,000/60,000 psi. Used on all sealing head assemblies for SL-IV, SL-V, E-Series & S-Series units with a 15 to 60 horsepower rating.

05116777



UHP Check Valve Gland Nut, .88 plunger units.
90,000 psi. Used on all sealing head assemblies for PRO® units.

20481660



SPACERS

HP Sealing Head Spacer, 1.13 plunger units.
60,000 psi. Used on all SL-V units with a 75 to 200 horsepower rating.

05144597



HP Sealing Head Spacer, 60,000 psi.
Used on SL-IV Plus units with a 15, 30, 50 or 60 horsepower rating.

05144696





MISCELLANEOUS PARTS & SUPPLIES



KMT Genuine Parts
Your business is worth it.

CUSTOMER TESTIMONIALS



John Dacier, Madison Polymeric Engineering

My experience with KMT makes me feel like I have a true partner in our relationship with this supplier. It is a pleasure to work with a company as professional, well run and well-staffed as KMT.

madpoly.com



Eric Hughes, Multec Packaging

KMT service is second to none and is the reason I only buy and will only buy KMT machines & parts period. The KMT Service Team is World Class!

multecpkging.com



Lothar Ingenrieth, Borgers USA

I think that the KMT PM Service is a valuable tool to keep the downtime to a minimum and get a good understanding on when to order spare parts

Borgers-group.com











Ryan Walsh, Owner, Ridiculous Winches

I have always flown the KMT flag proudly. The KMT Service Team has always been a HUGE help also and VERY friendly with all of the information. Needless to say, the KMT water jet pump runs BEAUTIFULLY!

Ridiculouswinches.com

DESCRIPTION

PART No.

<p>Filter Housing Assembly – LP Water, .75 FNPT connections, stainless steel, manual relief valve. (Uses Part Number 49834716 Filter Element). Replaces Part #05038690</p>	<p>72118339</p>	
<h2>FILTER ELEMENTS</h2>		
<p>LP Water 10 micron, 10.0 long, polypropylene.</p>	<p>10106722</p>	
<p>LP Water 40 micron, 10.0 long, polypropylene.</p>	<p>10100782</p>	
<p>LP Water 10 micron, 20.0 long, polypropylene.</p>	<p>49834716</p>	
<p>Filter Strainer, 50 NPTF, 40 Mesh, polypropylene.</p>	<p>20412815</p>	
<h2>VANE PUMPS</h2>		
<p>200 psi, 1.33 gpm, Stainless Steel, CW ROT For 15 to 60 horsepower intensifiers with temperature probe connected to the booster pump.</p>	<p>05071659</p>	
<p>200 psi, 1.33 gpm, Stainless Steel Used on all SL-V, E-Series and S-Series units. For 15 to 60 horsepower intensifiers that have no switch connected to the booster pump.</p>	<p>49887094</p>	
<p>Water Modulating Valve</p>	<p>10091866</p>	

LOW PRESSURE WATER SYSTEMS

HYDRAULIC SYSTEM

O RINGS

DESCRIPTION

PART NO.

FILTER ELEMENTS

Hydraulic, 6 micron, 4.0 long, spin on.
For 15 to 60 horsepower units.

05049689



Hydraulic, 10 micron, 9.40 long, spin on.
For 75 to 200 horsepower units.

05104187



Pressure Gauge - 0-5,000 psi, .25 bottom mount
For .88 plungers, SL-IV and SL-V.

05045497



Knob Adjuster- Used on all Hydraulic Cartridge Valve
Assembly Pressure Relief, 25-3000 psi, SL-V, E-Series
and S-Series units.

10187052



Directional Control Valve - Electric, 24V DC, D03, 4-way
Pilot section for SL-IV

05017553



Directional Control Valve Assembly, 24V DC, D08,
.055 orifice. For SL-IV & SL-V 30, 50, 60 horsepower
intensifiers

20437164



O-RINGS

SEALING HEADS

O-Ring - 129, 1.56 x 1.75 x .09, Buna-N, D-70

10074904

O-Ring - 131, 1.69 x 1.88 x .09, Buna-N, D-70
Used on all PRO® units.

10146082

O-Ring, Metric, 3MM x 1XX, Buna-N, D-70
Used on SL-III and SL-IV units

05049853

O-Ring - 212, .88 x 1.13 x .13, Viton, D-75

10074367



DESCRIPTION

PART No.

O-RINGS

TOPWORKS

O-Ring - 132, 1.75 x 1.94 x .09, Buna-N, D-70
Used on all 55,000 and 60,000 psi units.

10074920

O-Ring - 214, 1.0 x 1.25 x .13, Buna-N, D-70
Used on all S50 units and all SL-V and E-Series units with a 15 to 60 horsepower rating.

10074409

O-Ring - 240, 3.75 x 4.0 x .13, Buna-N, D-70
Used on all SL-V, E-Series and S-Series units with a 15 to 60 horsepower rating.

10075000

O-Ring - 218, 1.25 x 1.50 x .13, Polyurethane, D-70

05087713

O-Ring - 115, .69 x .88 x .09, Buna-N, D-70
Used on all PRO® units.

05144191



O-RINGS

INLINE FILTER

O-Ring - 012, .38 x .50 x .06, Viton, D-75
Used in BF 103473 Filter Assembly

10074599



O-RINGS

HOSES

GAUGES

DESCRIPTION

PART No.

O-RINGS

PNEUMATIC VALVES

O-Ring – 035, 2.25 x 2.38 x .06, Viton, D-75

Used on all 60,000 and 90,000 psi N/O pneumatic actuator assy's.

10074565

O-Ring – 143, 2.44 x 2.63 x .09, Viton, D-75

Used on all 60,000 and 90,000 psi N/O pneumatic actuator assy's.

10074714

O-Ring – 038, 2.63 x 2.75 x .06, Viton, D-70

Used on all 60,000 and 90,000 psi N/C pneumatic actuator assy's.

10177806

O-Ring – 044, .08 x .20 x .06, Viton, D-75

Used on all 60,000 and 90,000 psi N/C pneumatic valve assy's.

49895584



O-RINGS

CUTTING HEADS

O-Ring – 013, .44 x .56 x .06, Buna-N, D-70

Used on Abrasive Inlet Adapter, IDE **Cutting Head**. Used on IDE II & IDE PRO heads.

10074870

O-Ring – 012, .38 x .50 x .06, Buna-N, D-70

Used on AutoLine PRO cutting head assy's.

05077078

O-Ring – 012, .38 x .50 x .06, Polyurethane, D-70

Used on AutoLine & AutoLine II cutting head assy's.

05081518

O-Ring – 016, .63 x .75 x .06, Polyurethane, D-70

Used on AutoLine I cutting head assy's.

05092887

O-Ring – 014, .50 x .63 x .06, Polyurethane, D-70

Used on AutoLine I cutting head assy's.

05104930

O-Ring – 011, .31 x .44 x .06, Aflas, D-70 . Used on

AutoLine II & AutoLine PRO cutting head assy's.

20445476











DESCRIPTION

PART No.

HOSES

GAUGES

ELECTRICAL

DESCRIPTION	PART No.	Image
<h2>HOSES</h2>		
<p>Polyurethane Tubing - .38, Clear</p>	49885361	
<p>Push-on Hose - .50, 300 psi, Blue</p>	20421272	
<p>PVC Tubing - .50 x .748, Reinforced, Static-free</p>	05076963	
<p>Flexible Tubing - .50, Nylon</p>	05044532	
<h2>GAUGES</h2>		
<p>Pressure Gauge – 0-200 psi, .25 NPT, back mount, Stainless Steel.</p>	05139506	
<p>Pressure Gauge - 0-5,000 psi, .25 bottom mount For .88 plungers, SL-IV and SL-V.</p>	05045497	
<p>Pressure Gauge - 0-100,000 psi, .25 HP, 4.25" Face Bottom Mount. For use on 60,000 psi pumps.</p>	20443831	
<p>Pressure Gauge - 0-100,000 psi, .25 HP, Bottom Mount 6" Face, Glycerin filled. For use on 60,000 psi pumps.</p>	05125836	
<p>Pressure Gauge - 0-150,000 psi, .38 HP, Flush Mount 6" Face, Glycerin filled. For use on 90,000 psi pumps. Requires 20464745 Adapter.</p>	20467883	

DESCRIPTION

PART No.

PROXIMITY SWITCH KITS

E50, 55,000/60,000 psi

Used on all SL-IV, SL-V, E-Series and S-Series units with a 15 to 60 horsepower rating.

Replaces Part #05127584

20453934



60,000 psi, 75-200 horsepower

Used on all 1-1/8" plunger topworks

Used on all 90,000 psi PRO® units.

20453925



Conduit - Extra Flexible - .25, Stainless steel

20422988

Conduit - Extra Flexible - .38, Stainless steel

10186153

Conduit - Extra Flexible - .56, Stainless steel

05086905



Solenoid Valve - 24V DC

49888035



Output Module - Single Point, 24V DC, 3 amp

10146363



Inlet Pressure Switch, 30 psi, Stainless Steel

05140751



Directional Control Valve - Electric, 24V DC, D03, 4-way
Pilot section for SL-IV.

05017553



DESCRIPTION

PART No.

<p>Directional Control Valve Assembly, 24V DC, D08, .055 orifice. For SL-IV & SL-V 30, 50, 60 horsepower intensifiers.</p>	<p>20437164</p>	
<p>LIGHT BULBS</p> <p>24V. For use with Klockner Moeller Switches</p> <p>24V AC/DC. For AB 800F</p>	<p>05050216</p> <p>20484737</p>	
<p>PRESSURE TRANSDUCERS</p> <p>Pressure Transducer - 0-75,000 psi</p> <p>UHP Pressure Transducer - 0-90,000 psi</p>	<p>49838478</p> <p>20481140</p>	
<p>PICO Fuse</p>	<p>49885866</p>	
<p>Hose – Ferrule, .25 x .265 x .718, Brass</p> <p>Hose – Ferrule, .38 x .265 x .718, Brass</p> <p>Hose – Ferrule, .56 x .265 x .718, Brass</p>	<p>20422970</p> <p>10083897</p> <p>05131347</p>	

ELECTRICAL

MAINTENANCE TOOLS

LUBRICANTS

DESCRIPTION	PART NO.	
<p>TOPWORKS</p> <p>Cylinder Wrench 60,000 psi</p>	05066139	
<p>HP Seal Removal Tool .88 Plunger, 60,000 psi</p> <p>HP Seal Removal Tool 1.13 Plunger, 60,000 psi</p>	10148674 05146618	 
<p>Hydraulic Tensioner Assembly, PRO® Intensifier 90,000 psi</p>	20476132	
<p>Plate Glass Pane 8.0 x 8.0 x .25</p>	10149052	
<p>Cylinder Clamp, PRO® Intensifier 90,000 psi</p>	20476495	
<p>Plunger Removal Tool .88 Plunger, 60,000/90,000 psi</p>	20477460	
<p>Plunger Removal Tool 1.13 Plunger, 60,000 psi</p>	20477469	
<p>Crowfoot Wrench 1.625, .38 drive</p>	20477489	
<p>Vee Block Cradle</p>	20484961	
<p>HP Seal Removal Tool Stand - 60,000 psi</p>	80078330	

DESCRIPTION

PART No.

MAINTENANCE TOOLS

LUBRICANTS

CONING & THREADING

TOPWORKS

End Cap Wrench - 6x/8x, HSEC, 60,000 psi

80079239



Emery Cloth - 320 Grit, 9.0 x 11.0

10149029

Emery Cloth - 400 Grit, 9.0 x 11.0

10149037

Emery Cloth - 600 Grit, 9.0 x 11.0

10149045

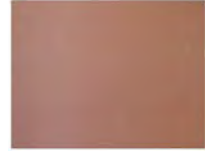

LUBRICANTS

Pure Goop Thread Lubricant - 1.0 pound

05026281

Pure Goop Thread Lubricant - 1.0 ounce

10084440

NLGI-2 Swivel Grease - 14.0 ounce

10067189

FML-2 Grease - FDA Approved - 14.5 ounce

10087385

Super-O-Lube O-Ring Grease - .07 ounce

20485968

Threadlocker Adhesive – 242, .50 ML

20487868

Threadlocker Primer - 1.75 ounce

20494983

JL-M Thread Lubricant - 16.0 ounce

49832199

JL-M Thread Lubricant - 15 ML

80082191



DESCRIPTION

PART No.

CONING & THREADING

Tool Kit - Hand Coning/Threading Tools
Kit includes .25, .38 and .56 hand coning & hand threading tool.

20454198



Tool Kit - Power Coning/Threading Tools
Kit includes .25, .38 and .56 power coning & power threading tool

20454201



BLADE

.25, Hand or Power, Coning

05108808

.38, Hand or Power, Coning

05108824

.56, Hand or Power, Coning

05108816



RETAINER

.25, Hand or Power, Bronze, Threading

05108741

.38, Hand or Power, Bronze, Threading

05108758

.56, Hand or Power, Bronze, Threading

05108766

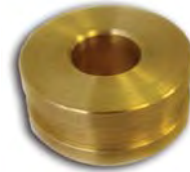

RETAINER

.25, Power, Bronze, Coning

05109814

.38, Power, Bronze, Coning

05109822

.56, Power, Bronze, Coning

05109830



TUBE VISE

.25

05108782

.38

05108790

.56

05108774



DESCRIPTION

PART No.

CONING TOOL ASSEMBLIES

Includes 4 oz Coning Lubricant

.25, Hand

05108832

.38, Hand

05108857

.56, Hand

05108840



.25, Power

05109897

.38, Power

05109889

.56, Power

05109871



THREADING TOOL ASSEMBLIES

Includes 4 oz Coning Lubricant

.25, Hand

05108865

.38, Hand

05108873

.56, Hand

05108881

.25, Power

05122742

.38, Power

05120258

.56, Power

05122759



DESCRIPTION

PART NO.

CONING & THREADING

THREADING DIE

1/4-28 LH, .25, Hand or Power

05108899

3/8-24 LH, .38, Hand or Power

05108915

9/16-18 LH, .56, Hand or Power

10078301



COLLET

Collet - .25, Hand Coning, Stainless Steel

05108972

Collet - .38, Hand Coning, Stainless Steel

05108964

Collet - .56, Hand Coning, Stainless Steel

20439964



PNEUMATIC VALVES

Kit - Seal Tools, 60,000/90,000 psi Pneumatic Valves
Kit includes the positioning, push and installation tools used to service all HP and UHP pneumatic valves.

20470475



Kit - N/C Actuator Assembly, 60,000/90,000 psi
Kit includes top and bottom protector tool, and snap ring pliers to service all HP and UHP, N/C pneumatic actuator assemblies.

80077795



Seal Positioning Tool
NO/NC valves, 2-port dump valve. 60,000/90,000 psi

05067350

Seal Positioning Tool
Quick Release Valve, 3-port dump valves

49833114



MANUALS**DVD INCLUDED**

KMT Waterjet Pumps combine all the unique capabilities and advantages of waterjet cutting systems with the reliability, ease of operation and service support that have made KMT Waterjet Systems a leader in waterjet technology.

Operations and Maintenance Manual for SL-V 30

20412890

Operations and Maintenance Manual for SL-V 50

20413039

Operations and Maintenance Manual for SL-V 60

20413062

Operations and Maintenance Manual for SL-V 75

20413096

Operations and Maintenance Manual for
Streamline S-30

20425545

Operations and Maintenance Manual for
Streamline PRO® 60

20477256

Operations and Maintenance Manual for SL-V 15

20492248

Operations and Maintenance Manual for S-50

20479050

Operations and Maintenance Manual for
Streamline PRO® 125

20485224



**PLEASE HAVE YOUR
PUMP SERIAL
NUMBER AVAILABLE
WHEN ORDERING
MANUALS.**

KMT Waterjet is a leading manufacturer of waterjet cutting systems and developer of "Cutting Edge Solutions" for customers in a very wide range of industries. The focus of the company is on intelligently developing systems and parts for ease of use and reliable operation by customers. The strength of the company is found in the strong waterjet experience (tracing back to 1971) of the

employees, the largest network of system integrators in the world, the continual investment in research and development and the ability to use customer feedback. The world's largest network of system integrators and support people are available to assist with more information at any time. *For the best waterjet system, rely on the "Cutting Edge Solutions" delivered by KMT Waterjet.*



Order Online Now!
www.ahbinc.com

If you do not already have a kmtgenuineparts.com log-in, you will need to first call Customer Service at 800-991-4225, and they will be happy to set you up with your personalized log-in information.

• Toll Free Order-line: **800-991-4225** • E-mail: **customerservice@ahbinc.com**

Advancing Waterjet Technology
Worldwide Sales and Support Network
Making Waterjet Systems Easier to Use, with Greater Reliability
CSA and CE Certified
Trained, Certified Technicians
© 2014



**COMPLETE
METALWORKING
SOLUTIONS**

(800) 991-4225

www.ahbinc.com

ISO Certified

customerservice@ahbinc.com

